

SUGGESTED RETAIL PRICE LIST

Effective AUGUST 1, 2020



BEFCO

40 YEARS STRONG!



Since 1980 BEFCO has developed, tested, manufactured and improved lawn and ground care attachments right here in North Carolina. BEFCO's commitment to design and to manufacture all key components in our machines has earned the company its reputation for high quality manufacturing with no compromise.

Anyone who has owned a BEFCO unit will tell you that it is an investment that repays for itself many times over throughout the years. Customers know that when purchasing a BEFCO implement, support is always available if assistance is ever needed. This is why when people ask us what BEFCO stands for, we say

"Best Equipment a Farmer Can Own"!



INDEX**GROOMING MOWERS**

CYCLONE C30-CE5	2
CYCLONE C30	4
CYCLONE C50	6
CYCLONE C70	8
CYCLONE FLEX	10
CYCLONE SUPER-FLEX	12

FLAIL MOWERS, FLAIL SHREDDERS

HURRICANE H40	14
HURRICANE H40-S	16
HURRICANE H70	18
DESTROYER D90	20

CHIPPERS

BUSHMASTER	22
-------------------	----

ROTARY CUTTERS

TORNADO BRC	23
TORNADO RMD	24
TORNADO RHD	25

ROTARY TILLERS

TILL-RITE T30	26
TILL-RITE T40	28
TILL-RITE T50	30
TILL-RITE T60	32
TILL-RITE T70	34

SEEDERS, OVERSEEDERS

GREEN-RITE	36
SEED-RITE	38

POST HOLE DIGGERS

MOLE	40
-------------	----

FERTILIZER SPREADERS

BABY-HOP	42
POLY BABY-HOP	43
HOP	44
POLY-HOP	45
TURBO-HOP 301	46
TURBO-HOP 303	46

GROUND ENGAGE EQUIPMENT

CORE AERATOR SD	48
CORE AERATOR HD	49
SOIL PULVERIZERS SD	50
SOIL PULVERIZERS HD	51
BOX SCRAPER	52
GRADING SCRAPER	53
REAR BLADE SD	54
REAR BLADE HD	55
LANDSCAPE RAKE	56

HAY EQUIPMENT

SICKLE BAR MOWERS	57
FINGER WHEEL RAKES	58
FINGER WHEEL "V" RAKES	59
TEDDERS	60
WINDROWER RAKES	61

QUICK HITCH

QUICK HITCH	62
--------------------	----

OPTIONALS

	63
--	----

CYCLONE C30-CE5



Three spindle engine driven grooming mower

- Ideal for lawn tractors, ATVs & UTVs.
- Rear discharge.
- 4 solid rubber tires to guarantee a perfectly level cut.
- Stamped steel reinforced wheel arm attached by 5 bolts for maintaining a consistent cutting height.
- Spindle shafts greased from the top for easy service.
- Hitch: Cat. 1 ball for rear mounting and 2" receiver hitch for front mounting.
- 10 gauge reinforced mower deck.
- Cutting heights: from 1" to 4".
- Heavy duty reinforced belts (BX).
- Powerful 11.5 HP Briggs & Stratton (OHV) engine with centrifugal clutch.
- 3 quart fuel tank.
- Safety kill switch.
- Heavy duty, one piece, balanced steel pulleys.
- Stamped steel wheel yokes.

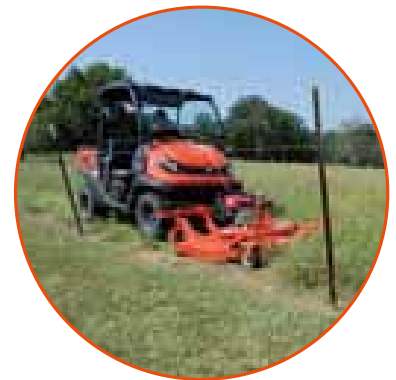

STANDARD

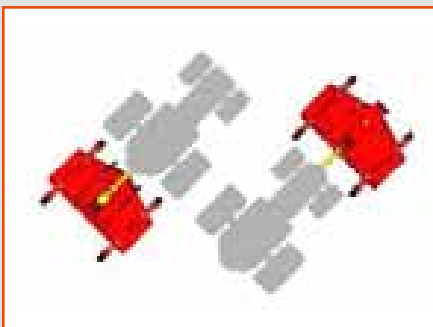

Reversible hitch for front or rear mounting















Capable of being center mounted or offset left or right



Up to 48" offset

Bid Term - 2/22/19 - 2/21/21; Extended to 2/21/22

C30-CE5H

											
in	in	in	lbs	lbs	rpm	fpm	N°	in	N°	N°-in	
60"	62"	0-48"	388	495	2,673	14,173	3	1"-4"	2 BX	4-8.4"x3.2"	Briggs & Stratton 11.5 HP

\$ 3,436



Front mount application with 2" receiver hitch



Height adjustment bar

Bid Term - 2/22/19 - 2/21/21; Extended to 2/21/22

CYCLONE C30

16-30 HP (12-22 KW)
 540 rpm - cat. 1



Rear discharge three spindle grooming mower

- Highly engineered & rugged gearbox.
- Front & rear tractor mounting.
- 4 rubber swivel tires to guarantee a perfectly level cut.

- Floating 3 point linkage, cat. 1.
- 10 gauge reinforced mower deck.
- Stamped steel reinforced wheel arm attached by 5 bolts for maintaining a consistent cutting height.
- Stamped steel wheel yokes.
- Cutting heights: from 1" to 4".
- Spindle shafts greased from the top for easy service.
- Heavy duty reinforced belt (BX).
- Heavy duty, one piece, balanced steel pulleys.
- Heavy duty shielded PTO shaft (1 3/8" ASAE cat. 2).



Heavy duty reinforced belt (BX) with automatic belt tensioner



Axial grease fittings for easy and accurate lubrication

STANDARD



Reversible three point hitch for front or rear tractor mounting



Gearboxes manufactured by Befco















Stamped steel wheel arms attached by five bolts



Choice of hard or air tires



MODEL	C30-RD4H	C30-RD5H	C30-RD6H	C30-RD4A	C30-RD5A	C30-RD6A
	HARD TIRES			AIR TIRES		
 HP	16-30	20-30	25-30	16-30	20-30	25-30
 in	48"	60"	72"	48"	60"	72"
 in	51"	62"	74"	51"	62"	74"
 lbs	340	375	440	329	364	429
 lbs	440	490	570	429	479	559
 rpm	3,037	2,803	2,278	3,037	2,803	2,278
 fpm	13,188	14,763	14,566	13,188	14,763	14,566
 N°	3	3	3	3	3	3
 in	1"-4"	1"-4"	1"-4"	1"-4"	1"-4"	1"-4"
 N°	1 BX	1 BX	1 BX	1 BX	1 BX	1 BX
 N°-in	4-8.4"x3.2"	4-8.4"x3.2"	4-8.4"x3.2"	4-9"x3.5"	4-9"x3.5"	4-9"x3.5"
 1 3/8"	ASAE cat. 2	ASAE cat. 2	ASAE cat. 2	ASAE cat. 2	ASAE cat. 2	ASAE cat. 2
\$	\$ 2,677	\$ 2,813	\$ 3,065	\$ 2,649	\$ 2,785	\$ 3,037



Before Price List - 8-1-2020

CYCLONE C50

20-50 HP (15-37 KW)
540 rpm - cat. 1



Rear discharge three spindle grooming mower

- Highly engineered & rugged gearbox with cooling fins.
- Spiral gears guarantee strength and quietness.
- Cutting heights: from 1" to 5".
- Front & rear tractor mounting.
- 4 rubber swivel tires with bearings to guarantee a perfectly level cut.
- Stamped steel reinforced wheel arm attached by 8 bolts for maintaining a consistent cutting height.
- Floating 3 point linkage, cat. 1.
- 8 gauge reinforced mower deck.

- Spindle shafts greased from the top for easy service.
- Safety chain shield standard.
- Two heavy duty reinforced belts (SPBX).
- Heavy duty, one piece, balanced steel pulleys.
- Heavy duty shielded PTO shaft (1 3/8" ASAE cat. 3).
- Stamped steel wheel yokes.

STANDARD

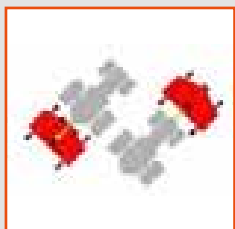

Reversible three point hitch for front & rear tractor mounting

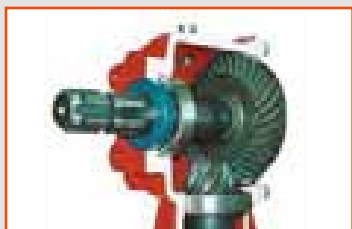

Gearboxes, manufactured by Befco, equipped with spiral gears ensure better power transmission, increase longevity and reduce noise















Choice of standard blades, high lift blades, mulching blades and flat blades



Choice of hard or air tires with ball bearings



MODEL	C50-RD5H	C50-RD6H	C50-RD7H	C50-RD5A	C50-RD6A	C50-RD7A
	HARD TIRES			AIR TIRES		
 HP	20-50	25-50	30-50	20-50	25-50	30-50
 in	60"	72"	84"	60"	72"	84"
 in	62"	74"	86"	62"	74"	86"
 lbs	550	600	690	534	584	674
 lbs	665	730	835	649	714	819
 rpm	3,210	2,605	2,195	3,210	2,605	2,195
 fpm	16,929	16,732	16,338	16,929	16,732	16,338
 N°	3	3	3	3	3	3
 in	1"-5"	1"-5"	1"-5"	1"-5"	1"-5"	1"-5"
 N°	2 SPBX	2 SPBX	2 SPBX	2 SPBX	2 SPBX	2 SPBX
 N°-in	4-10"x3.2"	4-10"x3.2"	4-10"x3.2"	4-11"x4"	4-11"x4"	4-11"x4"
 1 3/8"	ASAE cat. 3	ASAE cat. 3	ASAE cat. 3	ASAE cat. 3	ASAE cat. 3	ASAE cat. 3
\$	\$ 3,722	\$ 3,935	4,599	\$ 3,674	\$ 3,887	\$ 4,551

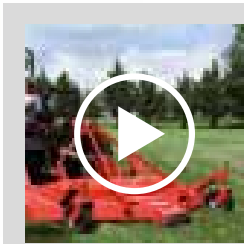

Axial grease fittings for easy and accurate spindle lubrication



Two heavy duty reinforced belts (SPBX) with manual tensioner provide over 180° coverage of all pulleys and reduce belt maintenance

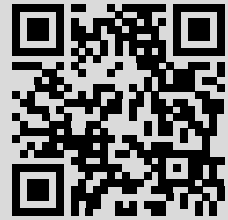



CYCLONE C70

30-70 HP (22-52 KW)
 540 rpm - cat. 1















Heavy duty rear discharge three spindle grooming mower

- Highly engineered & rugged gearbox with cooling fins.
- Cutting heights: from 1.3" to 5.3".
- Front & rear tractor mounting.
- 4 rubber swivel tires with bearings to guarantee a perfectly level cut.
- Stamped steel reinforced wheel arm attached by 8 bolts for maintaining a consistent cutting height.
- Floating 3 point linkage, cat. 1.
- Front antiscalping roller standard.

- 8 gauge reinforced mower deck.
- Three spindle rotors with free swinging blades per rotor.
- Spindle shafts greased from the top for easy service.
- Two heavy duty reinforced belts (CX).
- Heavy duty, one piece, balanced steel pulleys.
- Heavy duty shielded PTO shaft (1 3/8" ASAE cat. 4).
- Safety chain shield standard.
- Stamped steel wheel yokes.



MODEL	C70-090H	C70-110H	C70-090A	C70-110A	
	HARD TIRES		AIR TIRES		
	HP	30-70	40-70	30-70	40-70
	in	90"	110"	90"	110"
	in	92"	112"	92"	112"
	lbs	1,237	1,390	1,137	1,290
	lbs	1,267	1,420	1,167	1,320
	rpm	1,750	1,562	1,750	1,562
	fpm	14,106	14,998	14,106	14,998
	N°	6	6	6	6
	in	1.3"-5.3"	1.3"-5.3"	1.3"-5.3"	1.3"-5.3"
	N°	2 CX	2 CX	2 CX	2 CX
	N°-in	4-12"x4"	4-12"x4"	4-13"x6.5"	4-13"x6.5"
	1 3/8"	ASAE cat. 4	ASAE cat. 4	ASAE cat. 4	ASAE cat. 4
\$		\$ 7,073	\$ 8,361	\$ 7,233	\$ 8,521

STANDARD

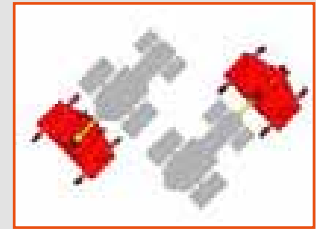

Reversible three point hitch for front or rear tractor mounting



Gearboxes manufactured by Befco



Stamped steel wheel arms attached by eight bolts

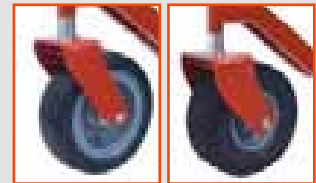

Choice of hard or air tires



Axial grease fittings for easy and accurate spindle lubrication



Chains provide safety from thrown objects



Standard front antiscalping roller



Rotor with free swinging blades

CYCLONE FLEX

25-80 HP (19-60 KW)
540 rpm









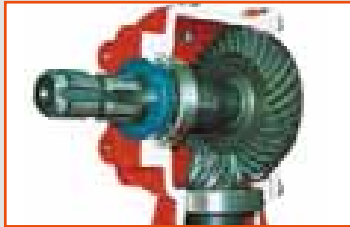



Pull type gang grooming mowers

- Heavy duty transport frame.
- Cutting heights: from 1" to 5".
- Pull type mower with high flotation transport tires (20.5"x8"x10").
- Single action hydraulic folding wing system for easy transport & storage.
- Transport width 8'4" max.
- Telescoping wings that allow for adjustable cutting width to increase or decrease mower overlap.
- Constant velocity driveline with slip clutch (1 3/8" ASAE cat. 6).
- Stamped steel reinforced wheel arm attached by 8 bolts for maintaining a consistent cutting height.
- 3 front antiscalping rollers standard.
- Safety chain shield standard.
- 8 gauge reinforced mower decks.
- Remote safety locks for local transport & deck kick out attachments.
- Completely independent free floating mowing decks for a perfect cut on uneven terrain.
- Unique double pivot floating linkage.
- 12 rubber tires with bearings (4 per deck) to guarantee a perfectly level cut.
- Heavy duty, one piece, balanced steel pulleys.
- Two heavy duty reinforced belts per deck (SPBX).
- Single unit gearboxes with cooling fins.
- Spiral gears guarantee strength and quietness.
- Stamped steel wheel yokes.
- Single unit driveline with shear pin safety.

STANDARD



Gearboxes, manufactured by Befco, equipped with spiral gears ensure better power transmission, increase longevity and reduce noise

MODEL	312-FLXH	315-FLXH	317-FLXH	312-FLXA	315-FLXA	317-FLXA
	HARD TIRES			AIR TIRES		
 HP	25-80	30-80	35-80	25-80	30-80	35-80
 ft	12'	15'	17'	12'	15'	17'
 in	91"	97"	100"	91"	97"	100"
 in	74"	92"	103"	74"	92"	103"
 lbs	2,742	2,874	2,995	2,694	2,826	2,947
 N°	9	9	9	9	9	9
 in	1"-5"	1"-5"	1"-5"	1"-5"	1"-5"	1"-5"
 N°	6 SPBX	6 SPBX	6 SPBX	6 SPBX	6 SPBX	6 SPBX
 N°-in	12-10"x3.2"	12-10"x3.2"	12-10"x3.2"	12-11"x4"	12-11"x4"	12-11"x4"
 N°/ft	2-4' mowers & 1-5' mower	2-5' mowers & 1-6' mower	3-6' mowers	2-4' mowers & 1-5' mower	2-5' mowers & 1-6' mower	3-6' mowers
 1 3/8"	ASAE cat. 6 cv, slip clutch	ASAE cat. 6 cv, slip clutch	ASAE cat. 6 cv, slip clutch	ASAE cat. 6 cv, slip clutch	ASAE cat. 6 cv, slip clutch	ASAE cat. 6 cv, slip clutch
\$	\$ 19,494	\$ 21,283	\$ 22,089	\$ 19,350	\$ 21,139	\$ 21,945

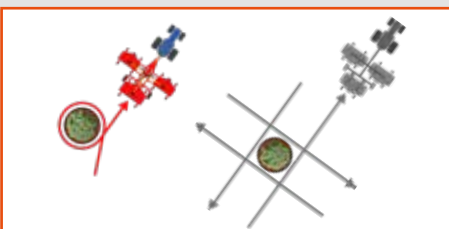

The frame design along with our CV driveline allows Flex mowers to circle trees and obstacles in one pass where competitors require multiple passes.



Hexagonal yokes on front tires of rear mower deck to prevent slippage on slopes



Standard front antiscaling roller



CYCLONE SUPER-FLEX

35-80 HP (26-60 KW)
 540 rpm









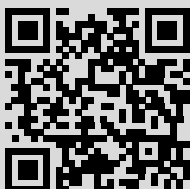
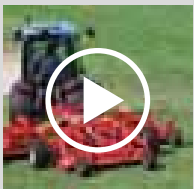

Pull type gang grooming mowers

- Extra heavy duty transport frame.
- Cutting heights: from 1" to 5".
- Pull type mower with high flotation transport tires (23"x10.5"x12").
- Single action hydraulic folding wing system for easy transport & storage.
- 3 front antiscalping rollers standard.
- Telescoping wings that allow for adjustable cutting width to increase or decrease mower overlap.
- Constant velocity driveline with slip clutch (1 3/8" ASAE cat. 6).
- Stamped steel reinforced wheel arm attached by 8 bolts for maintaining a consistent cutting height.
- Stamped steel wheel yokes.
- 8 gauge reinforced mower deck.



- Safety chain shield standard.
- Single unit driveline with shear pin safety.
- Remote safety locks for local transport & deck kick out attachments.
- Completely independent free floating mowing decks for a perfect cut on uneven terrain.
- Unique double pivot floating linkage.
- 12 rubber tires with bearings (4 per deck) to guarantee a perfectly level cut.
- Wide high flotation air tires 13"x6.5".
- Heavy duty, one piece, balanced steel pulleys.
- Two heavy duty reinforced belts per deck (SPBX).
- Single unit gearboxes with cooling fins.
- Spiral gears guarantee strength and quietness.



MODEL		412-SFL	415-SFL	417-SFL	420-SFL
	HP	35-80	40-80	45-80	50-80
	ft	12'	15'	17'	20'
	in	91"	97"	100"	114"
	in	74"	92"	103"	116"
	lbs	3,090	3,267	3,438	3,747
	N°	9	9	9	9
	in	1"-5"	1"-5"	1"-5"	1"-5"
	N°	6 SPBX	6 SPBX	6 SPBX	6 SPBX
	N°-in	12-13"x6.5"	12-13"x6.5"	12-13"x6.5"	12-13"x6.5"
	N°-ft	2-4' mowers & 1-5' mower	2-5' mowers & 1-6' mower	3-6' mowers	3-7' mowers
	1 3/8"	ASAE cat. 6 cv, slip clutch	ASAE cat. 6 cv, slip clutch	ASAE cat. 6 cv, slip clutch	ASAE cat. 6 cv, slip clutch
\$		\$ 22,735	\$ 23,905	\$ 25,915	\$ 29,254



Double pivot floating linkage for a perfect cut on uneven terrain



Telescopic wings that allow for adjustable cutting width to increase or decrease mower overlap



Gearboxes, manufactured by Befco, equipped with spiral gears to increase strength and quietness



Air tires 13"x6.5"

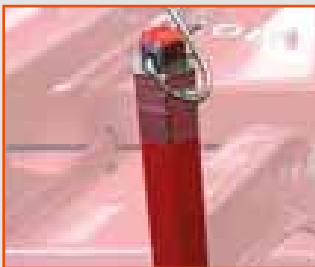

Hexagonal yokes on front tires of rear mower deck prevent slippage on slopes



Heavy duty center-splitter gearbox

HURRICANE H40





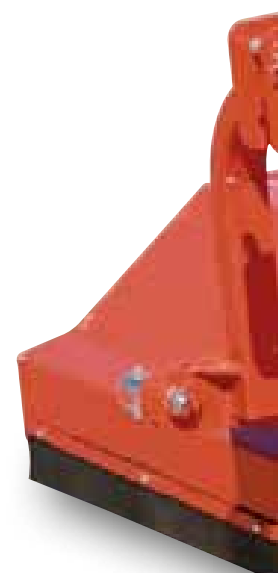







16-40 HP (12-30 KW)

540 rpm - cat. 1



Flail mower

- Cutting heights: from 1" to 5".
- Choice of fine cut blades at 90° angles, reverse "Y" blades, paddle blades or hammer type blades.
- Dethatching blades available.
- Adjustable cutting height roller with scraper.
- Heavy duty shielded PTO shaft (1 3/8" ASAE cat. 3).
- Sealed rotor bearings.
- Front & rear tractor mounting.
- Electronically balanced rotor.
- Heavy duty, one piece, balanced steel pulleys.
- 2 Heavy duty reinforced notched belts (SPBX).
- Automatic belt tensioner.
- 3 point linkage, cat. 1.
- Floating top link.
- Highly engineered & rugged gearbox.
- Offset from center: 3" on H40-048, 8.5" on H40-060, & 6.5" on H40-072.
- Rubber safety shielding.

MODEL		H40-048	H40-060	H40-072
	HP	16-40	20-40	25-40
	in	48"	60"	72"
	in	54"	64"	76"
	lbs	418	456	528
	lbs	556	593	638
	rpm	2,278	2,278	2,278
	fpm	8,858	8,858	8,858
	N°	48	64	76
	in	1"-5"	1"-5"	1"-5"
	N°	2 SPBX	2 SPBX	2 SPBX
	1 3/8"	ASAE cat. 3	ASAE cat. 3	ASAE cat. 3
		\$ 3,560	\$ 3,816	\$ 4,199

STANDARD

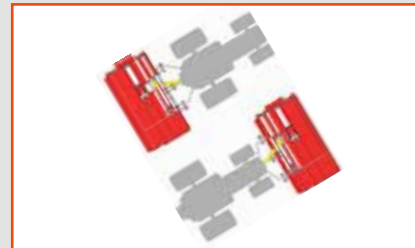

Reversible three point hitch for front or rear tractor mounting



Gearbox manufactured by Befco



Choice of fine cut blades, dethatching blades, reverse 'Y' blades, paddle blades or hammer type blades



Double belt transmission with automatic belt tensioner



HURRICANE H40-S













16-40 HP (12-30 KW)
540 rpm - cat. 1



Side-shift flail mower

- Cutting heights: from $\frac{3}{4}$ " to $2\frac{3}{8}$ ".
- Manual or optional hydraulic side-shift up to 16".
- Dual rear roller mounting position, inside or outside the cutting chamber.
- Manual belt tensioner without spring loaded idlers.
- Choice of fine cut blades at 90° angles, reverse "Y" blades, paddle blades or hammer type blades.
- Dethatching blades available.
- Adjustable cutting height roller with scraper or self cleaning roller when mounted inside the cutting chamber.
- Heavy duty shielded PTO shaft (1 $\frac{3}{8}$ " ASAE cat. 3).
- Sealed rotor bearings.
- Front & rear tractor mounting.
- Heavy duty, one piece, balanced steel pulleys.
- 2 Heavy duty reinforced notched belts (SPBX).
- 3 point linkage, cat. 1.
- Standard front rubber safety shielding or optional front steel deflectors.



MODEL		H40-S48	H40-S60	H40-S72
	HP	16-40	20-40	25-40
	in	48"	60"	72"
	in	54"	64"	76"
	in	35"	46"	58"
	lbs	552	624	697
	lbs	690	762	835
	rpm	2,278	2,278	2,278
	fpm	8,858	8,858	8,858
	N°	48	64	76
	in	¾" - 2 ¾"	¾" - 2 ¾"	¾" - 2 ¾"
	N°	2 SPBX	2 SPBX	2 SPBX
	1 ¾"	ASAE cat. 3	ASAE cat. 3	ASAE cat. 3
\$		\$ 3,866	\$ 4,173	\$ 4,608



STANDARD

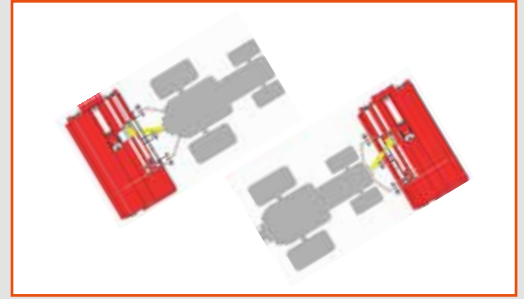

Reversible three point hitch for front or rear tractor mounting

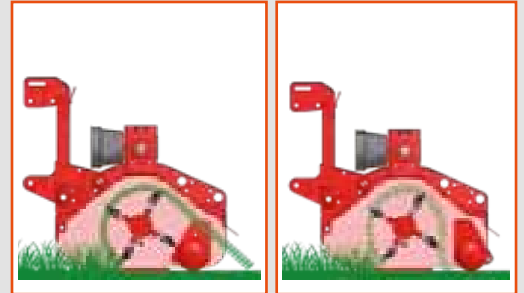

Dual rear roller mounting position, inside or outside the cutting chamber



Manual or hydraulic side-shift up to 16"



Manual belt tensioning



Choice of fine cut blades, dethatching blades, reverse Y blades, paddle blades or hammer type blades

HURRICANE H70

30-70 HP (22-52 KW)
540 rpm - cat. 1 & 2













Flail mower

- Cutting heights: from 3/4" to 6".
- Choice of fine cut blades at 90° angles, reverse "Y" blades, paddle blades or hammer type blades.
- Dethatching blades available.
- Adjustable cutting height roller with scraper.
- Driveline with overrunning clutch (1 3/8" ASAE cat. 4).
- Highly engineered & rugged gearbox.
- Belt shield fender.
- Front & rear tractor mounting.
- Electronically balanced rotor.
- Heavy duty, one piece, balanced steel pulleys.



- 2 heavy duty reinforced notched belts (CX).
- Manual belt tensioner.
- 3 point linkage, cat. 1 & 2.
- Floating top link.
- Forward & reverse rotor rotation; clockwise is standard.
- Cast iron rotor supports with spherical roller bearings.
- Rubber safety shielding.
- Replaceable skids.



MODEL		H70-060	H70-072	H70-088	H80-100
	HP	30-70	35-70	40-70	50-80
	in	60"	72"	88"	100"
	in	71"	85"	99"	110"
	lbs	869	955	1,078	1,486
	lbs	1,045	1,145	1,298	1,636
	rpm	2,080	2,080	2,080	1,873
	fpm	8,464	8,464	8,464	8,268
	N°	64	80	96	104
	in	3/4"-6"	3/4"-6"	3/4"-6"	3/4"-6"
	N°	2 CX	2 CX	2 CX	2 CX
	1 3/8" ASAE cat. 4 overrunning clutch	ASAE cat. 4 overrunning clutch	ASAE cat. 4 overrunning clutch	ASAE cat. 4 overrunning clutch	ASAE cat. 6 overrunning clutch
\$		\$ 7,123	\$ 7,611	\$ 8,110	\$ 11,707

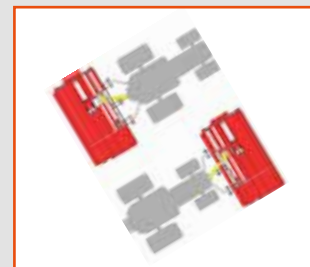

Reversible three point hitch for front or rear tractor mounting



Gearboxes manufactured by Befco



Belt shield fender



Cast iron rotor support with spherical roller bearings



Replaceable side skids

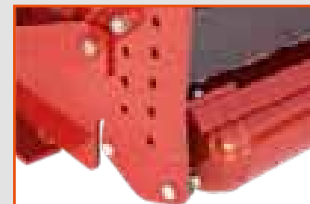

Adjustable cutting height roller with scraper



Choice of fine cut blades, dethatching blades, reverse 'Y' blades, paddle blades or hammer type blades

DESTROYER D90

40-90 HP (30-67 KW)
540 rpm - cat. 1 & 2

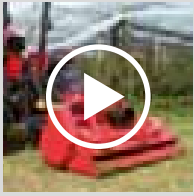

Commercial flail shredder with hydraulic side-shift

- Cutting heights: from 3/4" to 5".
- 3 point linkage, cat. 1 & 2.
- Front & rear tractor mounting.
- Driveline with overrunning clutch (1 3/8" ASAE cat. 6).
- Belt driven transmission with four heavy duty XPBX type belts and manual belt tensioner.
- Hydraulic side-shift with dual remotes.
- 12" side-shift on 60" model 16" on 72" & 88" models.
- Heavy duty hammer type blades.
- 2" cutting capacity.
- Rotor diameter 5 1/4", 5/16" thick rotor tube.
- Height adjustment rear roller with scraper standard.
- Rear roller diameter 6 5/8", 3/16" thick rotor tube.

MODEL		D90-060	D90-072	D90-088
	HP	40-90	50-90	60-90
	in	60"	72"	88"
	in	69"	81"	96"
	in	43"	54"	61"
	lbs	1,257	1,345	1,491
	lbs	1,360	1,450	1,600
	rpm	1,961	1,961	1,961
	fpm	8,268	8,268	8,268
	N°	16	20	24
	in	3/4"-5"	3/4"-5"	3/4"-5"
	N°	4 XPBX	4 XPBX	4 XPBX
	1 3/8"	ASAE cat. 6 overrunning clutch	ASAE cat. 6 overrunning clutch	ASAE cat. 6 overrunning clutch
\$		\$ 9,085	\$ 9,634	\$ 10,134



STANDARD

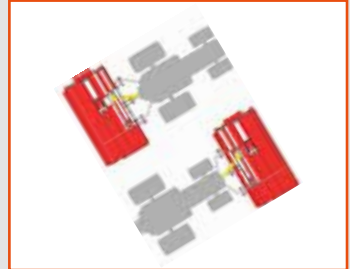

Reversible three point hitch for front or rear tractor mounting



Hammer type blades ideal for stalks up to 2" in diameter



Hydraulic cylinder for side shift

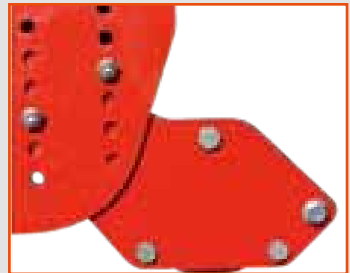

Rear roller for cutting height adjustment equipped with roller scraper



Four belts transmission

STANDARD



BUSHMASTER

30-50 HP (22-37 KW)
 540 rpm - cat. 1



Variable speed feed roller



Heavy duty BX type belt driven transmission

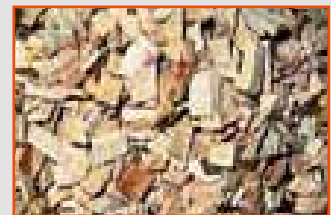

Consistent and fine wood chips



360° adjustable blower pipe extension

MODEL	BM6-800	
	HP	30-50
	lbs	900
	lbs	1,036
		360° swivel
	N°	6 BX
	in	6"
	rpm	1,512
	fpm	9,252
	N°	2
	1 3/8"	ASAE cat. 4
		\$ 8,669

Wood chipper

- Variable speed feed roller 70 or 45 fpm.
- Drum style chipping wheel.
- Two knives (7.5"x3"x3/8") modified A8 tool steel.
- Continuous chipping capacity of up to 6".
- Power feed on/off control bar.
- 3 point linkage, cat. 1.
- Heavy duty shielded PTO shaft (1 3/8" ASAE cat. 4).
- Built in high volume blower with optional 15" extension.
- Easy access to belts and chipper knives.





TORNADO BRC

20-60 HP (15-45 KW)
540 rpm - cat. 1



Standard duty rotary cutters

- Cutting heights: from 1" to 9 1/4".
- 10 gauge reinforced deck.
- Heavy duty shielded PTO shaft with shear bolt or slip clutch safety (1 3/8" ASAE cat. 4).
- Oval stump jumper standard on 48", 60" & 72" sizes.
- Spring steel blades.
- 1" cutting capacity.
- Front & rear safety shields standard.
- Laminated tail wheel (4"x8"x15").
- 3 point linkage, cat. 1.
- Floating top link.
- Round back frame.

MODEL	BRC-142	BRC-148	BRC-160	BRC-172	BRC-242	BRC-248	BRC-260	BRC-272
	SHEAR BOLT				SLIP CLUTCH			
HP	20-60	25-60	30-60	35-60	20-60	25-60	30-60	35-60
in	42"	48"	60"	72"	42"	48"	60"	72"
in	47"	56"	68"	79"	47"	56"	68"	79"
lbs	383	443	528	601	401	461	539	612
lbs	397	457	591	675	415	475	613	686
rpm	1,042	1,042	794	794	1,042	1,042	794	794
fpm	11,437	12,560	11,948	14,232	11,437	12,560	11,948	14,232
N°-in	2-3/8"x 2 3/4"	2-3/8"x 2 3/4"	2-1/2"x 3"	2-1/2"x 3"	2-3/8"x 2 3/4"	2-3/8"x 2 3/4"	2-1/2"x 3"	2-1/2"x 3"
in	1"-9 1/4"	1"-9 1/4"	1"-9 1/4"	1"-9 1/4"	1"-9 1/4"	1"-9 1/4"	1"-9 1/4"	1"-9 1/4"
N°-in	1-4"x8"x15"	1-4"x8"x15"	1-4"x8"x15"	1-4"x8"x15"	1-4"x8"x15"	1-4"x8"x15"	1-4"x8"x15"	1-4"x8"x15"
1 3/8"	ASAE cat. 4 shear bolt	ASAE cat. 4 shear bolt	ASAE cat. 4 shear bolt	ASAE cat. 4 shear bolt	ASAE cat. 4 slip clutch	ASAE cat. 4 slip clutch	ASAE cat. 4 slip clutch	ASAE cat. 4 slip clutch
\$	\$ 1,624	\$ 1,983	\$ 2,182	\$ 2,534	\$ 1,803	\$ 2,162	\$ 2,361	\$ 2,713

WARNING: Because of possible injury from thrown objects, all rotary cutters are potentially dangerous. Any rotary cutter intended for use along roadways or other locations where people may be present must be used with safety shielding in place.

TORNADO RMD

35-80 HP (26-60 KW)
 540 rpm - cat. 1

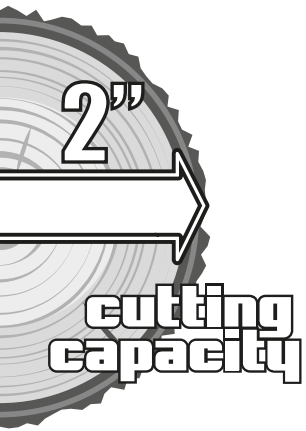

Medium duty rotary cutters

- Cutting heights: from 1" to 9 1/4".
- Replaceable skids.
- Highly engineered & rugged gearbox.
- Heavy duty shielded PTO shaft with slip clutch safety (1 3/8" ASAE cat. 4).
- 3 point linkage, cat. 1.
- Floating top link.
- Exceptionally heavy duty 1/2"x4" spring steel blades.
- 2" cutting capacity.
- Laminated tail wheel with tapered roller bearings (4"x8"x15").
- Oval heavy duty stump jumper standard.
- Heavy duty reinforced 8 gauge deck.
- Front & rear protective chain shields standard.

WARNING:

Because of possible injury from thrown objects, all rotary cutters are potentially dangerous. Any rotary cutter intended for use along roadways or other locations where people may be present must be used with safety shielding in place.

MODEL		RMD-360	RMD-372
	HP	35-80	40-80
	in	60"	72"
	in	68"	80"
	lbs	695	785
	lbs	695	785
	rpm	855	855
	fpm	13,189	15,748
	N°-in	2-1/2"x4"	2-1/2"x4"
	in	1"-9 1/4"	1"-9 1/4"
	N°-in	1-4"x8"x15"	1-4"x8"x15"
	1 3/8"	ASAE cat. 4 slip clutch	ASAE cat. 4 slip clutch
		\$ 3,960	\$ 4,400

STANDARD



Laminated tail wheel



Carbon steel rotor with free swinging blades



Safety chains & shields



Replaceable side skids



TORNADO RHD

50-100 HP (37-74 KW)
 540 rpm - cat. 1 & 2



cutting capacity

Heavy duty rotary cutters

- Cutting heights: from 2" to 8".
- Replaceable skids.
- Highly engineered & rugged gearbox.
- Heavy duty shielded PTO shaft with slip clutch safety (1 3/8" ASAE cat. 6).
- 3 point linkage, cat. 1 & 2.
- Floating top link.
- Front & rear protective chain shields standard.
- Exceptionally heavy duty 1/2"x4" spring steel blades.
- 3" cutting capacity.
- Laminated tail wheel with tapered roller bearings (5"x8"x15").
- Oval heavy duty stump jumper standard.
- Heavy duty reinforced deck.



MODEL	RHD-472	RHD-484	
	HP	50-100	60-100
	in	72"	84"
	in	76"	88"
	lbs	1,025	1,200
	lbs	1,025	1,200
	rpm	748	748
	fpm	13,878	16,191
	N°-in	2-1/2"x4"	2-1/2"x4"
	in	2"- 8"	2"- 8"
	N°-in	1-5"x8"x15"	1-5"x8"x15"
	1 3/8"	ASAE cat. 6 slip clutch	ASAE cat. 6 slip clutch
		\$ 4,966	\$ 5,676

WARNING:

Because of possible injury from thrown objects, all rotary cutters are potentially dangerous. Any rotary cutter intended for use along roadways or other locations where people may be present must be used with safety shielding in place.



Heavy duty free swinging blades mounted on a high carbon steel rotor protected by an oval stump jumper

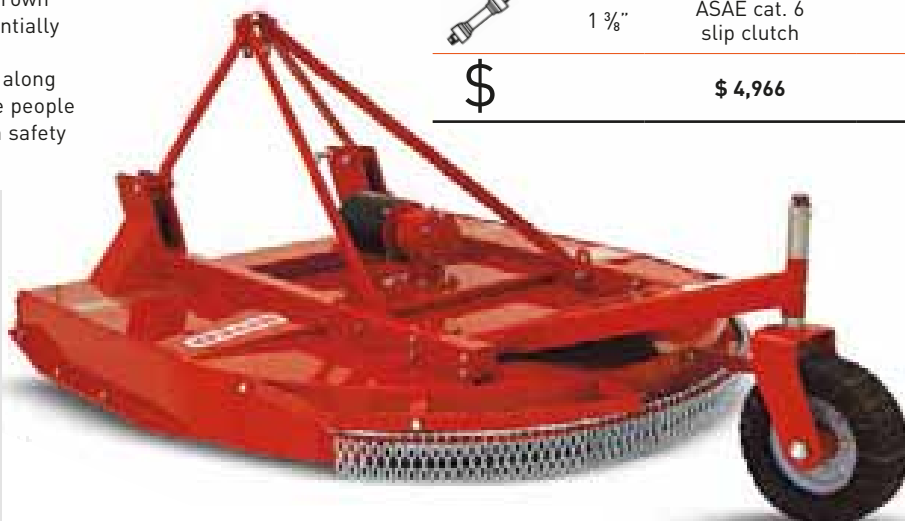













Before Price List - 8/1/2020

TILL-RITE T30

16-30 HP (12-22 KW)
540 or 2000 rpm - cat. 1



MODEL	T30-134	T30-142	T30-150	T30-234	T30-242	T30-250	T30-534	T30-542	T30-550
	SHEAR BOLT 540 rpm			SLIP CLUTCH 540 rpm			SHEAR BOLT 2000 rpm		
 HP	16-30	20-30	25-30	16-30	20-30	25-30	16-30	20-30	25-30
 in	34"	42"	50"	34"	42"	50"	34"	42"	50"
 in	39"	47"	55"	39"	47"	55"	39"	47"	55"
 in	24"	32"	40"	24"	32"	40"	24"	32"	40"
 lbs	297	341	374	308	352	385	297	341	374
 lbs	387	430	463	398	441	474	387	430	463
 N°	4	5	6	4	5	6	4	5	6
 N°	16	20	24	16	20	24	16	20	24
 z	14-16	14-16	14-16	14-16	14-16	14-16	9-22	9-22	9-22
 rpm	205	205	205	205	205	205	237	237	237
 in	7 1/4"	7 1/4"	7 1/4"	7 1/4"	7 1/4"	7 1/4"	7 1/4"	7 1/4"	7 1/4"
 1 3/8"	ASAE cat. 2 shear bolt	ASAE cat. 2 shear bolt	ASAE cat. 2 shear bolt	ASAE cat. 3 slip clutch	ASAE cat. 3 slip clutch	ASAE cat. 3 slip clutch	ASAE cat. 2 shear bolt	ASAE cat. 2 shear bolt	ASAE cat. 2 shear bolt
\$	\$ 2,330	\$ 2,406	\$ 2,543	\$ 2,424	\$ 2,500	\$ 2,637	\$ 3,085	\$ 3,161	\$ 3,298

Rotary tiller with manual side-shift Forward or reverse tilling rotation

- Highly engineered & rugged gearbox.
- Smooth manual side-shift system.
- Adjustable side skids for working depth control.
- Heavy duty shielded PTO shaft with shear bolt coupling (1 3/8" ASAE cat. 2) or slip clutch safety (1 3/8" ASAE cat. 3).
- Max. working depth 7 1/4".
- Parking stand.
- Reinforced lateral ASA 60 chain drive transmission in oil bath.
- Four blades per flange.
- High carbon solid steel round rotor shaft allows for a deeper working depth.
- Outward turned blades keep the rotor supports clean and maximize working width.
- Heavy duty full size blades.
- 3 point linkage, cat. 1.

STANDARD



Manual side-shift

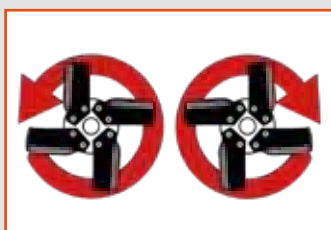

Forward or reverse tilling rotation



Gearbox manufactured by Befco



Lateral ASA 60 chain drive transmission in oil bath



Side skids for working depth control



TILL-RITE T40

20-40 HP (15-30 KW)
540 rpm - cat. 1













Rotary tiller with manual side-shift Forward or reverse tilling rotation

- Highly engineered & rugged gearbox.
- Smooth manual side-shift system.
- Adjustable side skids for working depth control.
- Heavy duty shielded PTO shaft with shear bolt coupling or slip clutch safety (1 3/8" ASAE cat. 3).
- Exchangeable sprockets for two working speeds.
- Flanged rotor shaft for easy removal & service.
- Parking stand.
- 3 point linkage, cat. 1.
- Lateral ASA 80 chain drive transmission in oil bath.
- Four blades per flange.



- High carbon solid steel round rotor shaft allows for a deeper working depth.
- Outward turned blades keep the rotor supports clean and maximize working width.
- Heavy duty full size blades.
- Wear protection on chain case.
- Max. working depth 7 1/4".



MODEL	T40-142	T40-150	T40-158	T40-166	T40-242	T40-250	T40-258	T40-266
	SHEAR BOLT				SLIP CLUTCH			
 HP	20-40	25-40	30-40	32-40	20-40	25-40	30-40	32-40
 in	42"	50"	58"	66"	42"	50"	58"	66"
 in	47"	55"	63"	72"	47"	55"	63"	72"
 in	32"	40"	48"	56"	32"	40"	48"	56"
 lbs	363	407	451	518	373	417	461	530
 lbs	481	519	540	607	491	529	550	619
 N°	5	6	7	8	5	6	7	8
 N°	20	24	28	32	20	24	28	32
 z	11-14	11-14	11-14	11-14	11-14	11-14	11-14	11-14
 rpm	231/375	231/375	231/375	231/375	231/375	231/375	231/375	231/375
 in	7 1/4"	7 1/4"	7 1/4"	7 1/4"	7 1/4"	7 1/4"	7 1/4"	7 1/4"
 1 3/8"	ASAE cat. 3 shear bolt	ASAE cat. 3 shear bolt	ASAE cat. 3 shear bolt	ASAE cat. 3 shear bolt	ASAE cat. 3 slip clutch	ASAE cat. 3 slip clutch	ASAE cat. 3 slip clutch	ASAE cat. 3 slip clutch
\$	\$ 2,889	\$ 3,011	\$ 3,116	\$ 3,426	\$ 2,983	\$ 3,105	\$ 3,210	\$ 3,520

STANDARD



Manual side-shift

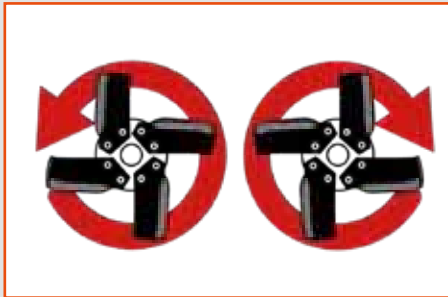

Forward or reverse tilling rotation



Gearbox manufactured by Befco



Lateral ASA 80 chain drive transmission in oil bath



Stamped steel rotor shaft supports and transmission

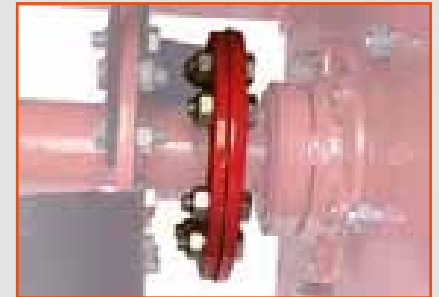

Rotor shaft with flanges for easy blade replacement



TILL-RITE T50













25-50 HP (19-37 KW)
540 rpm - cat. 1



Rotary tiller with manual side-shift Forward or reverse tilling rotation

- Highly engineered & rugged gearbox.
- Smooth manual side-shift system.
- Adjustable side skids for working depth control.
- Heavy duty shielded PTO shaft with slip clutch safety (1 3/8" ASAE cat. 4).
- Exchangeable sprockets for two working speeds.
- Flanged rotor shaft for easy removal & service.
- Parking stand.
- 3 point linkage, cat. 1.
- Lateral ASA 100 chain drive transmission in oil bath.
- Standard six blades per flange for greater stability and finer soil pulverization.
- Outward turned blades keep the rotor supports clean and maximize working width.
- Heavy duty full size tiller blades.
- Wear protection on chain case.
- Max. working depth 8 3/8".



MODEL		T50-350	T50-358	T50-366
	HP	25-50	30-50	35-50
	in	50"	58"	66"
	in	55"	63"	72"
	in	40"	48"	56"
	lbs	481	528	575
	lbs	625	670	708
	N°	6	7	8
	N°	36	42	48
	z	10-13	10-13	10-13
	rpm	226/383	226/383	226/383
	in	8 3/8"	8 3/8"	8 3/8"
	1 3/8"	ASAE cat. 4 slip clutch	ASAE cat. 4 slip clutch	ASAE cat. 4 slip clutch
\$		\$ 3,727	\$ 3,853	\$ 4,050

STANDARD



Manual side-shift

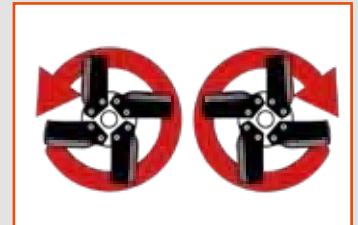

Forward or reverse tilling rotation



Gearbox manufactured by Befco



Lateral ASA 100 chain drive transmission in oil bath



Stamped steel rotor shaft supports and transmission



Rotor with 6 blades per flange

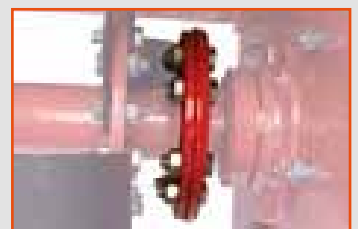

Rotor shaft with flanges for easy blade replacement



Before Price List 8-1-2020

TILL-RITE T60













35-60 HP (26-45 KW)
540 rpm - cat. 1



Rotary tiller with manual side-shift Forward or reverse tilling rotation

- Highly engineered & rugged gearbox.
- Smooth manual side-shift system.
- Adjustable side skids for working depth control.
- Heavy duty shielded PTO shaft with slip clutch safety [1 3/8" ASAE cat. 6].
- Flanged rotor shaft for easy removal & service.
- Parking stand.

- 3 point linkage, cat. 1.
- Lateral ASA 100 chain drive transmission in oil bath.
- Standard six blades per flange for greater stability and finer soil pulverization.
- Outward turned blades keep the rotor supports clean and maximize working width.
- Heavy duty full size tiller blades.
- Wear protection on chain case.
- Max. working depth 8 3/4".

MODEL		T60-366	T60-374
	HP	35-60	40-60
	in	66"	74"
	in	72"	81"
	in	56"	63"
	lbs	740	798
	lbs	864	910
	N°	8	9
	N°	48	54
	z	12-14	12-14
	rpm	221	221
	in	8 ¾"	8 ¾"
	1 ½"	ASAE cat. 6 slip clutch	ASAE cat. 6 slip clutch
\$		\$ 5,062	\$ 5,267

STANDARD



Manual side-shift

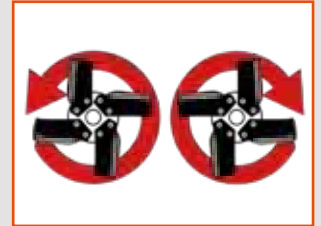

Forward or reverse tilling rotation



Gearbox manufactured by Befco

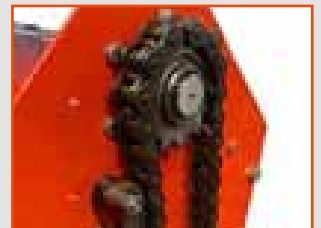

Lateral ASA 100 chain drive transmission in oil bath

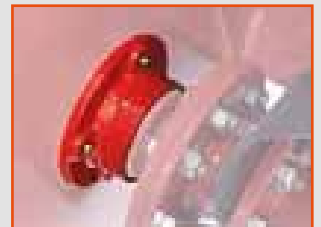

Stamped steel rotor shaft supports and transmission

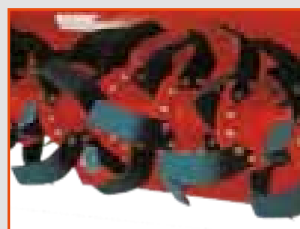

Rotor with 6 blades per flange

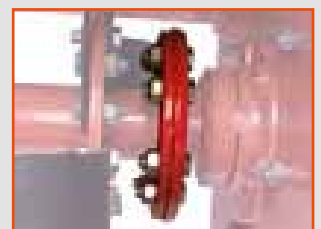

Rotor shaft with flanges for easy blade replacement



TILL-RITE T70

40-70 HP (30-52 KW)
540 rpm - cat. 1



Rotary tiller

Forward or reverse tilling rotation

- Highly engineered & rugged gearbox.
- Adjustable side skids for working depth control.
- Heavy duty shielded PTO shaft with slip clutch safety (1 3/8" ASAE cat. 6).
- Flanged rotor shaft for easy removal & service.
- Parking stand.
- 3 point linkage, cat. 1.
- Lateral ASA 100 chain drive transmission in oil bath.
- Standard six blades per flange for greater stability and finer soil pulverization.
- Outward turned blades keep the rotor supports clean and maximize working width.
- Heavy duty full size tiller blades.
- Wear protection on chain case.
- Max. working depth 8 3/4".



T70-382

STANDARD



HP	in	in	lbs	lbs	N°	N°	z	rpm	in	1 3/8"
40-70	82"	88"	879	1,009	10	60	12-14	221	8 3/4"	ASAE cat 6 slip clutch

\$ 5,514

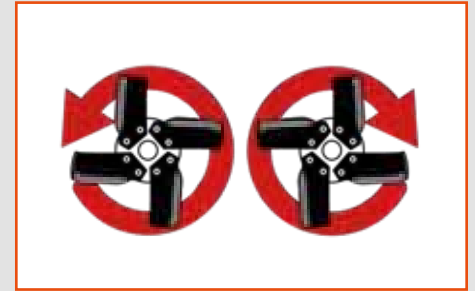

Forward or reverse tilling rotation



Gearbox manufactured by Befco



Lateral ASA 100 chain drive transmission in oil bath



Stamped steel rotor shaft supports and transmission

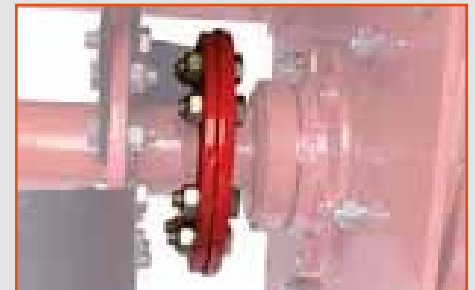

Rotor shaft with flanges for easy blade replacement



GREEN-RITE GRT

25-70 HP (19-52 KW)















540 rpm - cat. 1



Overseeder-aerator & seeder-cultivator

- Special 2-¹³/₁₆" spacing on rotor for aerating with 3 knives per flange; 4 knives on model 282.
- 2" to 3" suggested working depth with aerator rotor, 7 ¹/₄" working depth with tiller rotor; 8 ³/₄" on on model 282.
- Seed covering/dethatching adjustable tickler tines.
- High precision metering seed cups made from a nylon/fiberglass composite.
- Parking stand.
- Ground drive system for seed hopper.
- Large capacity seed hopper with agitator.
- Heavy duty shielded PTO shaft with slip clutch safety (1 ³/₈" ASAE cat. 3 for models 250, 258 & 266, cat. 6 for model 282).
- Corrugated depth control roller made with low weight nylon/fiberglass roller rings.
- Double sided, extra thin profile razor blades reduce impact when aerating over existing turf (available on request).



MODEL		GRT-250	GRT-258	GRT-266	GRT-282
	HP	25-45	30-45	32-45	40-70
	in	50"	58"	66"	82"
	in	57"	66"	74"	89"
	lbs	910	998	1,170	1,500
	lbs	1,160	1,245	1,390	1,760
	cu.ft	4.60	5.30	6.00	7.60
	N°	7	8	9	11
	N°	15	18	21	26
	N°	43	52	61	104
	z	11-14	11-14	11-14	12-14
	rpm	231	231	231	221
	in	7 1/4"	7 1/4"	7 1/4"	8 3/4"
	1 3/8"	ASAE cat. 3 slip clutch	ASAE cat. 3 slip clutch	ASAE cat. 3 slip clutch	ASAE cat. 6 slip clutch
		\$ 9,488	\$ 9,754	\$ 10,940	\$ 14,097

STANDARD



Aerator rotor with straight blades with 2-13/16" flange spacing



Corrugated roller with nylon/fiberglass rings to compact the ground for optimal seed germination



Precise seed metering cups



Seed calibration handle

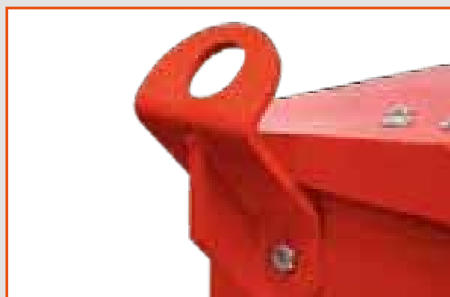

Lift hooks easy loading and unloading

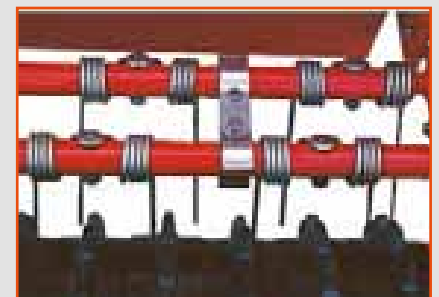

Tickler tines for partial or complete seed incorporation into the ground

SEED-RITE SRT

25-70 HP (19-52 KW)

cat. 1











Primary seeder

- 3 point linkage, cat. 1.
- 74" seeding width.
- Heavy duty frame.
- Heavy duty lid with seed splash guard.
- Hopper capacity 7.00 cu. ft.
- Seed box with steel shaft agitator.
- 10 high precision metering seed cups.
- Two lift hooks.
- Wide range of calibration settings per acre.
- Wind guarded seed drop.
- ASA 50 chains with chain tensioners.
- Front 11 1/2" diameter corrugated roller with 28 rings to drive the seed hopper.
- Rear corrugated roller with 29 rings, 9 1/2" in diameter made with low weight nylon/ fiberglass.
- Roller spindles: 1 3/8" front and rear, with greasable bearings.
- Two spring-tine track removers.



SRT-074

									
HP	in	in	lbs	lbs		cu.ft	N°	N°-Ø	N°-Ø
25-70	74"	80"	1,008	1,190	ASA 50	7	10	28-11 1/2"	29-9 1/2"

\$ 6,331



STANDARD



Dual front and rear corrugated roller equipped with nylon/fiberglass rings



Lift hooks easy loading and unloading



Precise seed metering cups

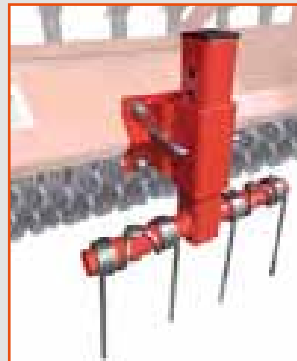

Spring-tine tractor tire track removers

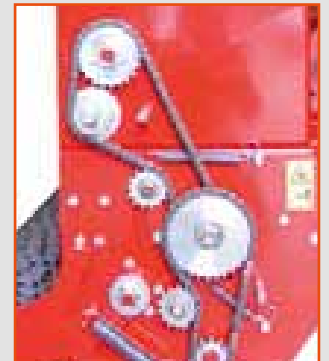

Seed distribution engaged by ASA 50 chain transmission



MOLE 100 / 200 / 300 / 400

15-90 HP (11-67 KW)
540 rpm - cat. 1 & 2



Post hole diggers & augers

- Heavy duty boom and yoke for extra strength and long lasting service.
- Choice of 6", 9", 12", 18", 24" & 30" augers.
- Rugged dependable gearbox at 540 rpm provides constant digging power.
- Individually replaceable knives and point.
- Fully welded flighting on all augers.
- Reinforced mounting collar on all augers.
- Safety shielding around auger & PTO.
- 2" output shaft on 200, 300 & 400 series.
- 1 3/8" output shaft with 5/8" adapter bushing on 100 series.

- Heavy duty shielded PTO shaft (1 3/8" ASAE cat. 3) on 200, 300 & 400 series.
- Heavy duty shielded PTO shaft (1 3/8" ASAE cat. 2) on 100 series.
- Fish-tail point standard.

STANDARD



Reinforced frame and three point hitch on model 300-512 & 400-512



Driveline with shear pin safety



Hook-up stand

		DIGGERS			
MODEL		100-512	200-512	300-512	400-512
	HP	15-25	18-40	18-50	18-90
	Ø in	2 7/8"	3 1/2"	3 1/2" reinforced	3 1/2" reinforced
	Ø in	2 3/8"	2 7/8"	2 7/8" reinforced	2 7/8" reinforced
	rpm	180	180	154	135
		3:1	3:1	3.5:1	4:1
	lbs	112	200	230	260
	lbs	165	235	275	305
		limited Cat.1	Cat.1	Cat.1&2	Cat.1&2
	1 3/8"	ASAE cat. 2 shear bolt	ASAE cat. 3 shear bolt	ASAE cat. 3 shear bolt	ASAE cat. 3 shear bolt
\$		\$ 1,118	\$ 1,202	\$ 1,459	\$ 1,772

		AUGERS								
MODEL		* 106-531	* 109-531	* 112-531	206-531	209-531	212-531	** 218-531	** 224-531	** 230-531
	in	6"	9"	12"	6"	9"	12"	18"	24"	30"
	L in	36"	36"	36"	48"	48"	48"	48"	48"	44"
	lbs	23	40	44	30	52	58	67	100	214
	S in	Single 3/16"	Double 3/16"	Double 3/16"	Single 3/16"	Double 3/16"	Double 3/16"	Double 1/4"	Double 1/4"	Double 15" & 30" 5/16"
\$		\$ 328	\$ 343	\$ 436	\$ 336	\$ 385	\$ 457	\$ 620	\$ 834	\$ 1,616

All post hole diggers are crated 2 each. Add \$50 net for single order units.

* Recommended for model 100-512.

** Available only for models 300-512 & 400-512.



Choice of 6, 9, 12, 18, 24 and 30" auger and 36" or 48" auger lengths



Replaceable knives and points

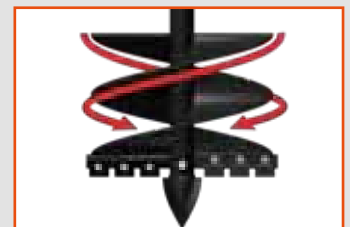

Heavy duty double-flighting on all augers

BABY-HOP POLY BABY-HOP







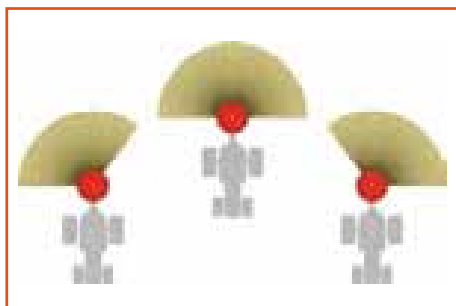

Fertilizer spreaders Ground driven pull type hitch

- One piece seamless hopper.
- Even left-center-right spread pattern.
- High flotation air tires.
- Easy connecting pull type hitch.
- Sturdy tubular frame.
- Hopper leveling adjustment.
- Sealed heavy duty gearbox with metal gears.
- Ground controlled distribution.
- Polyethylene hopper with stainless steel bottom standard on models 103-230 & 106-230.



Adjustable spread pattern

MODEL	BABY-HOP		POLY BABY-HOP	
	103-130	106-130	103-230	106-230
 lbs	62	84	62	84
 lbs	100	125	100	125
 cu.ft/lbs	3.71 / 237	5.30 / 339	3.71 / 237	5.30 / 339
 ft	3'-20"	3'-20"	3'-20"	3'-20"
 in	32"	35"	32"	35"
 in	39.6"	44.4"	39.6"	44.4"
 N°-in	2-13"x 6"	2-16"x 8"	2-13"x 6"	2-16"x 8"
\$	\$ 779	\$ 1,032	\$ 866	\$ 1,120

NOTE: Poundage capacity calculated @ 13-13-13 fertilizer weight of 64 lbs. per cu. ft.



STANDARD



Gate opening control



Sealed gearbox manufactured by Befco with metal gears

STANDARD

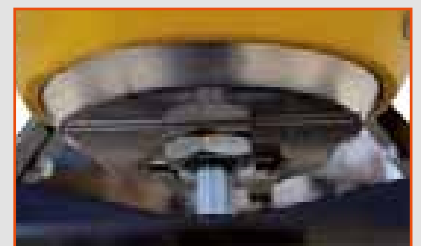

Bottom plate in stainless steel

Bid Term - 2/22/19 - 2/21/21; Extended to 2/21/22









HOP / POLY-HOP

16-50 HP (12-37 KW)
 540 rpm - cat. 1



Fertilizer spreaders

- One piece seamless hopper.
- Selective double gate opening on 206, 209 & 212.
- Adjustable ejector spoon to center spread on 203 model.
- Sealed heavy duty gearbox.
- Fixed agitator.
- Adjustable spreading fins on 209 & 212 models.
- Heavy duty shielded PTO shaft (1 3/8" ASAE cat. 1).
- Sturdy tubular frame.
- 3 point linkage, limited cat. 1 on 203 & 206 models, cat. 1 on 209 & 212 models.
- Quick hitch compatible standard on models 209, 212 and optional on models 203.
- Safety shields standard.

		HOP			
		203-120	206-121	209-121	212-121
	HP	16-30	16-30	20-50	20-50
	lbs	81	102	125	136
	lbs	116	145	160	171
	cu.ft/lbs	3.71 / 237	5.30 / 339	8.58 / 549	11.95 / 765
	ft	23'	23'	46'	46'
	in	32"	35"	42"	48"
	in	31"	34"	40"	46"
	1 3/8" ASAE cat. 1	ASAE cat. 1	ASAE cat. 1	ASAE cat. 1	ASAE cat. 1
		\$ 764	\$ 793	\$ 835	\$ 879

NOTE: Poundage capacity calculated @ 13-13-13 fertilizer weight of 64 lbs. per cu. ft.
 All Hop fertilizers are priced at 2 per pallet. Add \$25 net for single unit orders.
 Bid Term - 2/22/19 - 2/21/21; Extended to 2/21/22

Fertilizer spreaders with polyethylene hoppers

- Polyethylene hopper with stainless steel bottom standard.
- Sturdy tubular frame.
- Selective double opening gate on 206, 209 & 212 models.
- Heavy duty shielded PTO shaft (1 3/8" ASAE cat. 1).
- Sealed heavy duty gearbox.
- Fixed agitator.
- 3 point linkage, limited cat. 1 on 203 & 206 models, cat. 1 on 209 & 212 models.
- Quick hitch compatible standard on models 209, 212 and optional on models 203.
- Safety shields standard.

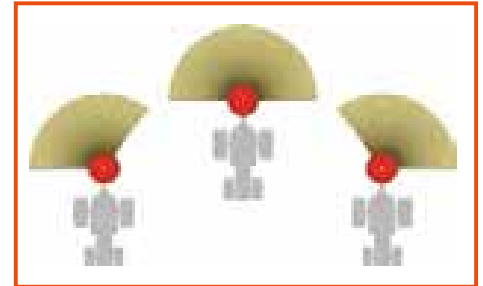
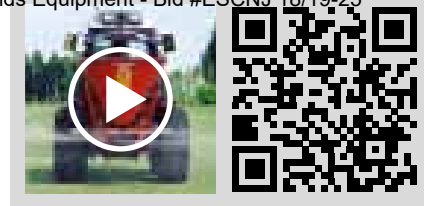

Adjustable spread pattern



POLY-HOP			
203-220	206-221	209-421	212-421
16-30	16-30	20-50	20-50
81	102	125	136
116	145	160	171
3.71 / 237	5.30 / 339	8.58 / 549	11.95 / 765
23'	23'	46'	46'
32"	35"	42"	48"
31"	34"	40"	46"
ASAE cat. 1	ASAE cat. 1	ASAE cat. 1	ASAE cat. 1
\$ 848	\$ 1,042	\$ 1,336	\$ 1,393

STANDARD

Stainless steel adjustable spreader wings on 209 & 212 models



Stainless steel hopper bottom plate



Stainless steel gates opening control on 206, 209 & 212 models



NOTE: Pounds capacity calculated @ 13-13-13 fertilizers weight of 64 lbs per cu. ft.
 All Hop fertilizers are priced at 2 per pallet. Add \$25 net for single units orders.

Bid Term - 2/22/19 - 2/21/21; Extended to 2/21/22

TURBO-HOP 301 / 303









20-60 HP (15-45 KW)
540 rpm - cat. 1 & 2



Pendular spreaders

- Sturdy tubular frame.
- Heavy duty cast iron gearbox in oil bath.
- Accurate flow control adjustment.
- Ideal for the distribution of fertilizer, seed, salt and sand where accuracy and precision in application are needed.
- Full spread or left / right discharge pattern.
- Polyethylene hopper.
- Spreader spouts made of nylon and reinforced fiberglass.
- Stainless steel opening control disc.
- Cast iron anti-wear agitator.
- 3 point linkage, cat. 1 on model 301 and cat. 1&2 on model 303.
- Heavy duty shielded PTO shaft (1 3/8" ASAE cat. 1) with shock absorber and shear bolt safety.
- Safety shields standard.



MODEL		301-300	301-400	303-600	303-800	303-999
	HP	20-60	20-60	20-60	20-60	20-60
	lbs	256	267	419	448	455
	mph	2 to 10	2 to 10	2 to 10	2 to 10	2 to 10
	cu.ft/lbs	9.00 / 576	12.80 / 820	20.6 / 1,318	30.3 / 1,939	36.1 / 2,310
	ft	17'-65'	17'-65'	17'-65'	17'-65'	17'-65'
	in	44"	48"	38"	43"	47"
	1 3/8"	ASAE cat. 1 shear bolt	ASAE cat. 1 shear bolt	ASAE cat. 1 shear bolt	ASAE cat. 1 shear bolt	ASAE cat. 1 shear bolt
		\$ 3,000	\$ 3,270	\$ 4,012	\$ 4,408	\$ 4,812

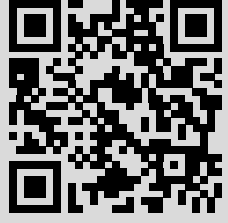
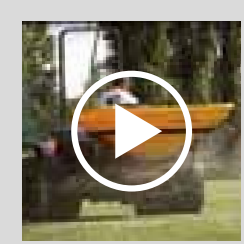

NOTE: Poundage capacity calculated @ 13-13-13 fertilizers weight of 64 lbs per cu. ft.



Adjustable spread pattern

STANDARD



Corrosion resistant polyethylene hopper



Heavy duty gearbox in oil bath manufactured by Befco



Distributing unit in stainless steel and agitator in stamped steel



Graded scale for accurate flow control adjustment

CORE AERATOR SD

20-50 HP (15-37 KW)
cat. 1



Standard duty core aerators

- Hub spacing 6 1/2".
- Special high tensile steel shafts on the rotors.
- 2 bronze bushings per rotor.
- 8 gauge formed steel support panels.
- All panels support rotors from all sides.
- 1 1/4" rotor support shaft.
- 3/8" formed Cat. 1 "A" frame.
- Machine equipped with spikes instead of spoons is available on request.
- 3 point linkage, Cat. 1.
- 6 spoons per hub.
- All flanges are welded to rotors.
- Flange thickness 3/16".
- 3 support stands.
- 3/4" hardened steel spoons.
- Front or rear tractor mounting.

MODEL		BCA-048	BCA-060	BCA-072
	HP	20-50	20-50	20-50
	in	48"	60"	72"
	in	54"	65"	78"
	lbs	284	357	401
	N°	4	5	6
	N°	8	10	12
	N°	48	60	72
	in	4 1/2"	4 1/2"	4 1/2"
	in	12" x 15"	19" x 15"	25" x 15"
	lbs	78 ea.	125 ea.	160 ea.
		\$ 2,325	\$ 2,438	\$ 2,634

STANDARD

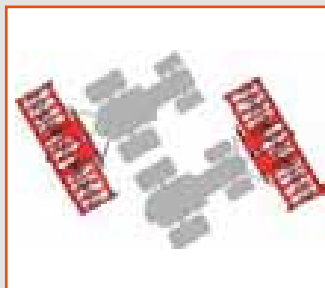

Front or rear tractor mounting



Both hub flanges are welded and equipped with two bronze bushings per rotor

Bid Term - 2/22/19 - 2/21/21; Extended to 2/21/22

OPTIONALS PAG. 73

CORE AERATOR HD

20-70 HP (15-52 KW)
 cat. 1 & 2



Heavy duty core aerators

- Hub spacing 6 1/2".
- Special high tensile steel shafts on the rotors.
- 2 bronze bushings per rotor.
- 3/16" formed steel support panels.
- All panels support rotors from all sides.

- 1 1/4" rotor support shaft.
- 3/8" formed Cat. 1 & 2 "A" frame.
- Machine equipped with spikes instead of spoons is available on request.
- 3 point linkage, Cat. 1 & 2.
- 8 spoons per hub.
- All flanges are welded to rotors.
- Flange thickness 3/16".
- 3/4" hardened steel spoons.
- Front or rear tractor mounting.
- 3 support stands.

STANDARD



Eight spoons per flange



Choice of hollow spoons or solid spikes

MODEL		BCA-260	BCA-272
	HP	20-70	20-70
	in	60"	72"
	in	65"	78"
	lbs	444	549
	N°	5	6
	N°	10	12
	N°	80	96
	in	4 1/2"	4 1/2"
	in	19" x 21"	25" x 21"
	lbs	170 ea.	220 ea.
\$		\$ 3,094	\$ 3,424

Bid Term - 2/22/19 - 2/21/21; Extended to 2/21/22

SOIL PULVERIZERS SD

25-50 HP (19-37 KW)
 cat. 1



Standard duty soil pulverizers

- 3/8" steel spikes fully welded in a timed scroll pattern on a heavy walled roller with two 160 lbs compression springs.
- Optional 2nd spiked roller available with two 80 lbs compression springs.
- 10" (49.1 lb/ft) frame beam.
- Reversible heat treated 1/2" x 2" shanks.
- 3 point linkage, cat. 1.
- 5 9/16" diameter spiked roller tube.
- Self aligning 1" bearings on roller.
- Formed plate "A" frame.

MODEL		BPL-048	BPL-060	BPL-072
	HP	25-50	25-50	25-50
	in	48"	60"	72"
	lbs	496	652	679
	lbs	544	702	729
	N°	17	21	25
	N°	70	88	106
	in	2 13/16"	2 13/16"	2 13/16"
	in	4 1/2"	4 1/2"	4 1/2"
	lbs	160 lbs per spring	160 lbs per spring	160 lbs per spring
		\$ 1,989	\$ 2,127	\$ 2,344

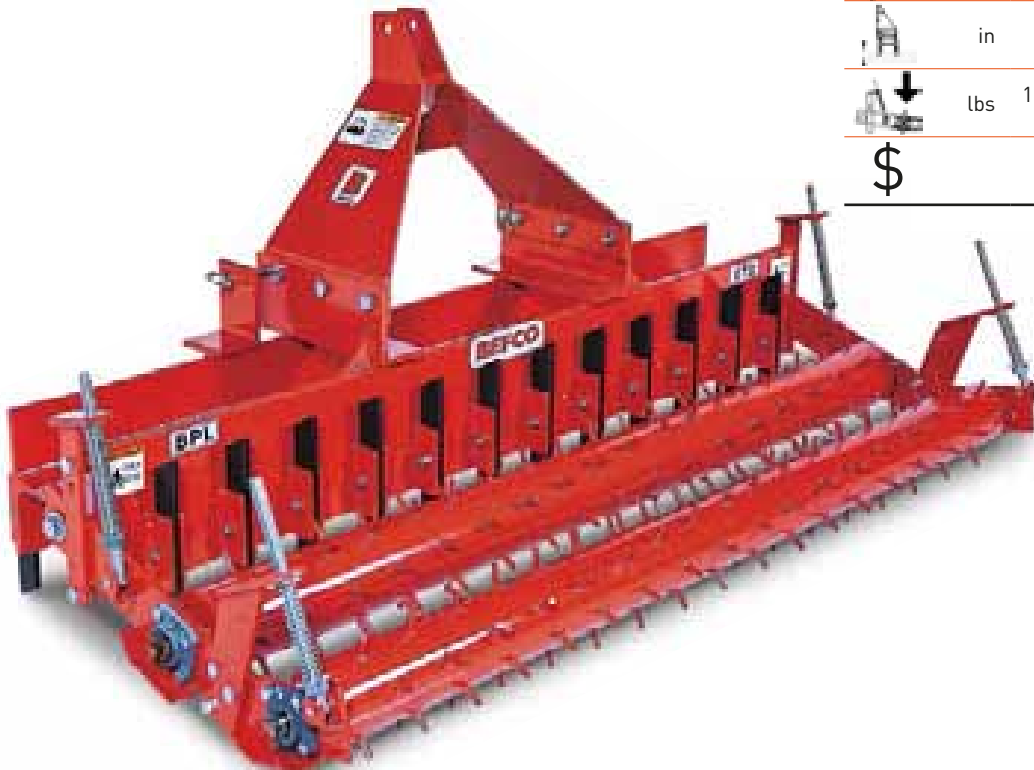

SOIL PULVERIZERS HD

40-90 HP (30-67 KW)
 cat. 1



Heavy duty soil pulverizers

- 3/8" steel spikes fully welded in a timed scroll pattern on a heavy walled roller with two 160 lbs compression springs.
- Optional 2nd spiked roller available with two 80 lbs compression springs.
- 12" (59.4 lb/ft) frame beam.
- Reversible heat treated 1/2" x 2" shanks.
- 3 point linkage, cat. 1.
- 6 5/8" diameter spiked roller tube.
- Self aligning 1" bearings on roller.
- Formed plate "A" frame.

MODEL	BPL-272	BPL-284
HP	40-90	40-90
in	72"	84"
lbs	781	875
lbs	846	940
N°	25	29
N°	106	124
in	2 13/16"	2 13/16"
in	4 1/2"	4 1/2"
lbs	160 lbs per spring	160 lbs per spring
\$	\$ 2,808	\$ 3,175

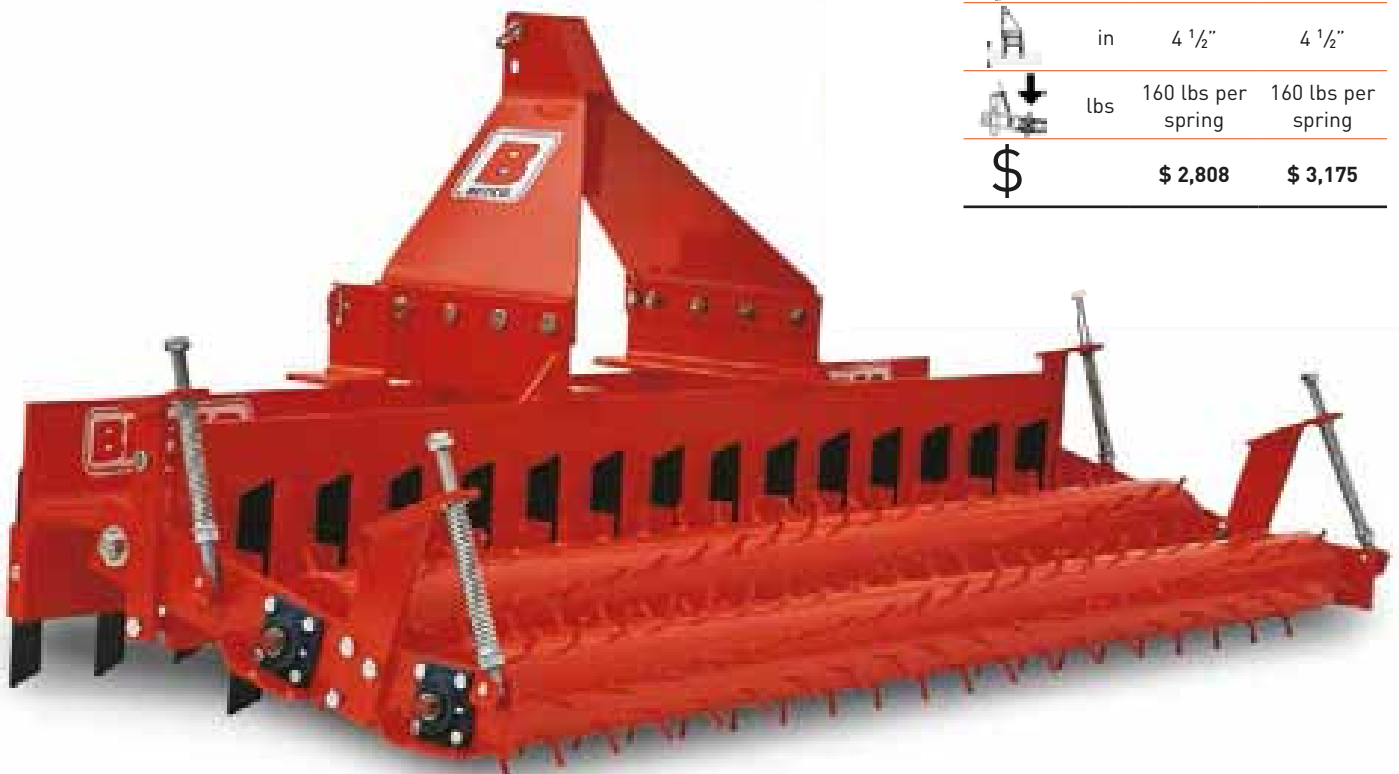

Before Price List - 8/1/2020

BOX SCRAPER

16-65 HP (12-48 KW)
 cat. 1



- Roll formed moldboard.
- 3 point linkage, cat. 1.
- 2 bolt-on 1/2" x 6" heat treated blades with reversible cutting edge.
- Hardened steel ripping shanks with replaceable tips.
- Reinforced box design.

MODEL	BBS-C48	BBS-060	BBS-072	BBS-084
	SUBCOMPACT SERIES		STANDARD DUTY SERIES	
HP	16-30	25-65	25-65	25-65
in	48"	60"	72"	84"
lbs	251	470	530	630
lbs	276	505	570	680
N°	4	5	6	7
\$	\$ 846	\$ 1,278	\$ 1,419	\$ 1,677

Standard duty series



Subcompact series

GRADING SCRAPER

16-65 HP (12-48 KW)
 cat. 1

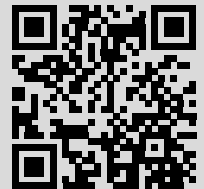
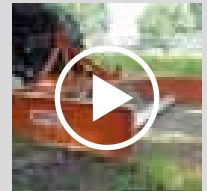

MODEL		BGS-C48	BGS-060	BGS-072	BGS-084
		SUBCOMPACT SERIES		STANDARD DUTY SERIES	
	HP	16-30	25-65	25-65	25-65
	in	48"	60"	72"	84"
	in	52"	64"	76"	89"
	lbs	350	592	703	764
	lbs	386	628	739	800
	N°	-	5	6	7
	in	10 3/4"	12 1/2"	12 1/2"	12 1/2"
	in	0"-1 1/2"	0"-1 1/2"	0"-1 1/2"	0"-1 1/2"
		1,139	1,459	1,613	1,872

- 3 point linkage, cat. 1.
- Adjustable height grading blades.
- Adjustable hardened steel ripping shanks with replaceable tips, on standard duty series.
- Heavy duty frame.
- 2 reversible and replaceable bolt-on 1/2" x 6" heat treated high carbon steel blades.
- Replaceable full length skid shoes.

STANDARD

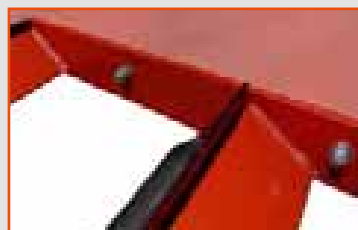

Adjustable height grading blades



Skid shoes

REAR BLADE SD

16-50 HP (12-37 KW)
 cat. 1



Standard duty rear blades

- 5 forward & 5 reverse positions on standard duty series.
- 3 forward and 3 reverse positions on subcompact series.
- Sturdy frame construction.
- Left or right offset.
- 3 tilt positions on standard duty series.
- 1/2" x 6" heat treated reversible cutting blade.
- 1/4" moldboard thickness.
- 3 point linkage, cat. 1.

MODEL		BRB-C48	BRB-C60	BRB-072	BRB-084
		SUBCOMPACT SERIES		STANDARD DUTY SERIES	
	HP	16-30	16-30	25-50	25-50
	in	48"	60"	72"	84"
	lbs	139	158	275	294
	lbs	189	208	325	344
		-	-	14°	14°
		16°	16°	16° & 32°	16° & 32°
	in	6"	6" or 12"	6" or 12"	6" or 12"
		\$ 730	\$ 758	\$ 1,046	\$ 1,084

All subcompact and standard duty blades are crated 2 each of the same model. Add \$50 net for single order units.

Standard duty series.

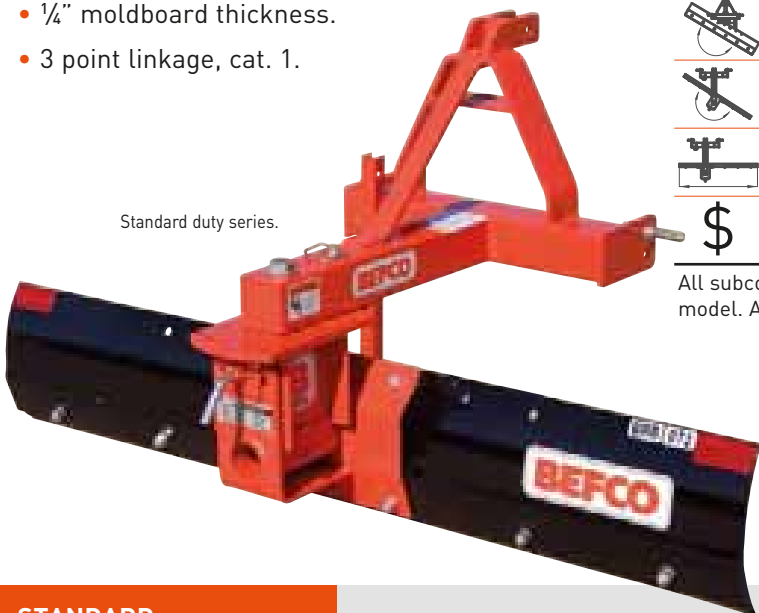

Subcompact series.



STANDARD

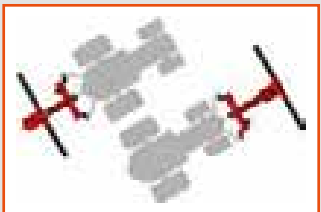

Front or rear tractor mounting

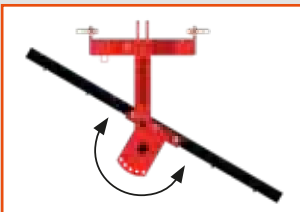

Up to 32° angling on standard duty blades

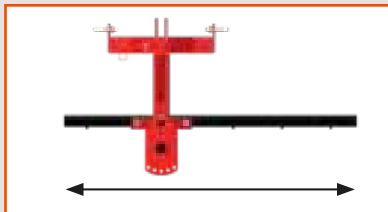

Up to 12" offset

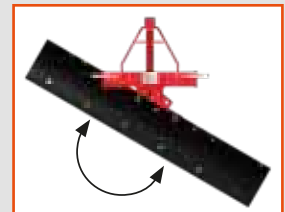

Up to 14° tilt on standard duty blades

Bid Term - 2/22/19 - 2/21/21; Extended to 2/21/22

REAR BLADE HD

30-80 HP (22-60 KW)
 cat. 1 & 2



Heavy duty rear blades

- 16 forward & 16 reverse positions.
- Right or left offset.
- 5 tilt positions.
- 3 point linkage, cat. 1 & 2.
- 1/2" x 6" heat treated reversible cutting blade.
- 1/4" moldboard thickness.
- Reinforced moldboard for increased strength.



MODEL	BRB-284	BRB-296
HP	30-80	30-80
in	84"	96"
lbs	524	561
lbs	602	644
	15° & 30°	15° & 30°
	up to 60°	up to 60°
in	up to 21"	up to 21"
\$	\$ 1,980	\$ 2,129

STANDARD

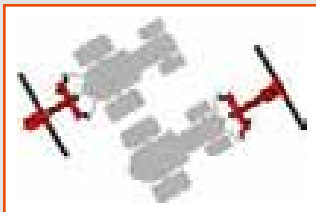

Front or rear tractor mounting

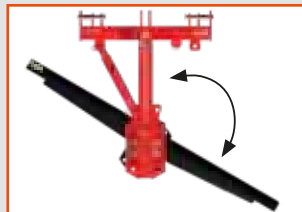

Up to 60° angling

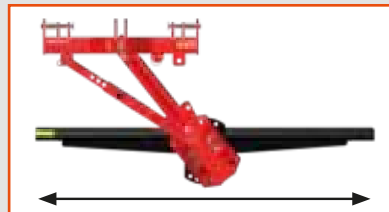

Up to 12" offset

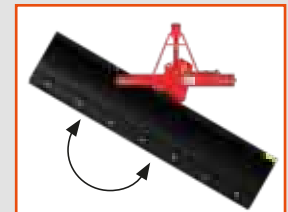

Up to 30° tilt

Bid Term - 2/22/19 - 2/21/21; Extended to 2/21/22

LANDSCAPE RAKE

16-65 HP (12-48 KW)
 cat. 1



- 5 forward & 5 reverse positions on standard duty series.
- 3 forward and 3 reverse on subcompact series.
- Sturdy frame construction.
- 2" center tine spacing.
- 2 hole tine 5/16" x 1" on standard duty series.
- 1 hole tine 5/16" x 1" on subcompact series.
- 3 point linkage, cat. 1.



STANDARD

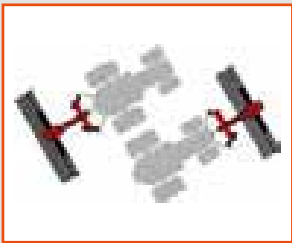

Front or rear tractor mounting



Up to 32° angling on standard duty rakes

	MODEL	BLR-C48	BLR-C60	BLR-072	BLR-084	BLR-096
		SUBCOMPACT SERIES		STANDARD DUTY SERIES		
	HP	16-30	16-30	25-65	25-65	25-65
	in	48"	60"	72"	84"	96"
	lbs	135	156	248	274	314
	lbs	180	198	293	319	359
		16°	16°	16° & 32°	16° & 32°	16° & 32°
	N°	24	30	36	42	48
		\$ 726	\$ 834	\$ 1,075	\$ 1,211	\$ 1,347

All subcompact and standard duty rakes are crated 2 each of the same model. Add \$50 net for single order units.

Bid Term - 2/22/19 - 2/21/21; Extended to 2/21/22

SICKLE BAR MOWERS

20-75 HP (15-56 KW)
 540 rpm - cat. 1 & 2



- 3 point linkage, cat. 1 & 2.
- Double action sickle bar.
- Single action hydraulic cylinder with restrictor.
- Safety release standard on all units.
- Transport lock bar secures cutting bar for transport and storage.
- Transport blade guard standard.
- Equipped with cylinder stop to raise cutting bar using tractor's hydraulic system.
- Ideal for set-aside, conservation acreage and ditchbank mowing.
- Delivered with extra cutting blade.
- Will mow 90° up and 55° down.
- Heavy duty shielded pto shaft (1 3/8" ASAE cat. 4).



BSB-284



STANDARD



Spring loaded blade guides for quick and easy blade replacement

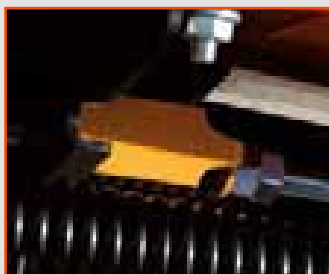

Easy to inspect and adjust belt tensioner

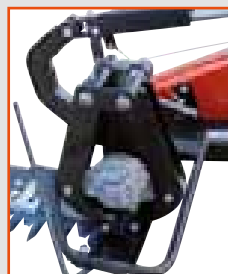

Cast aluminium connecting rods with cooling fins

MODEL	BSB-272	BSB-284	BSB-296
HP	20-75	20-75	20-75
in	72"	84"	96"
in	130"	142"	154"
lbs	628	650	672
lbs	717	750	782
mph	9	9	9
	Hydraulic	Hydraulic	Hydraulic
1 3/8"	ASAE cat. 4	ASAE cat. 4	ASAE cat. 4
\$	\$ 6,393	\$ 6,591	\$ 7,305

Bid Term - 2/22/19 - 2/21/21; Extended to 2/21/22



FINGER WHEEL RAKES

16-80 HP (12-60 KW)
 cat. 1

RS2-04V

- 3 point linkage, cat. 1.
- Cast steel hubs with greasable tapered bearings.
- Quick hitch compatible on models RS2-02R, RS2-03R, RS2-04V & RS2-06V
- Finger wheel rakes may also be used for spreading (2, 3, 4 & 6 wheel models only) or turning hay (RS2-04R & RS2-06R models only).
- Lifts hay gently, even from undulating terrain.
- Bent elbows allow better hay flow under heavy working conditions.

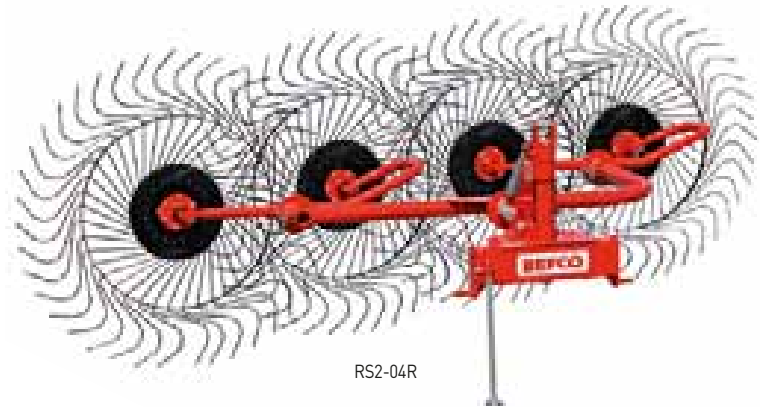

RS2-04R

STANDARD

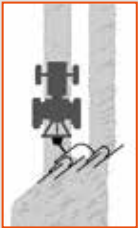
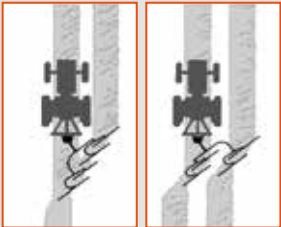

Rakes can be used for raking, turning and spreading

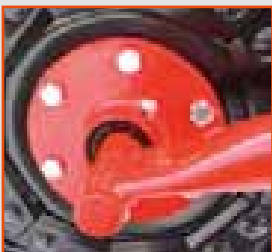

Cast steel hubs with greasable tapered bearings

MODEL		RS2-02R	RS2-03R	RS2-04R	RS2-05R	RS2-06R	RS2-04V	RS2-06V
	HP	16-30	16-30	30-80	30-80	30-80	16-30	16-30
	N°	2	3	4	5	6	4	6
	Ø in	56"	56"	56"	56"	56"	56"	56"
	N°	40	40	40	40	40	40	40
	Ø in	3/32"	3/32"	3/32"	3/32"	3/32"	3/32"	3/32"
	ft	4'3"	6'5"	8'6"	11'	12'9"	11'6"	15'10"
	ft	7'4"	8'4"	4'9"	7'5"	7'5"	10'2"	12'7"
	ft	7'6"	10'	12'10"	14'6"	17'3"	7'6"	10'
	mph	14	14	14	14	14	14	14
	lbs	194	291	388	495	602	353	547
		\$ 752	\$ 1,108	\$ 1,484	\$ 1,814	\$ 2,167	\$ 1,388	\$ 2,053

NOTE: For left hand models order with "L" suffix. (ie. RS2-04L)

Bid Term - 2/22/19 - 2/21/21; Extended to 2/21/22



HRC-08V

FINGER WHEEL "V" RAKES

16-80 HP (12-60 KW)

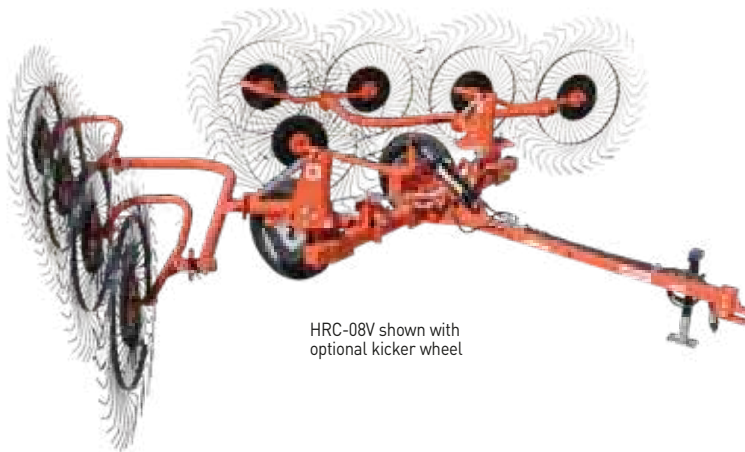

HRC-08V shown with optional kicker wheel

STANDARD

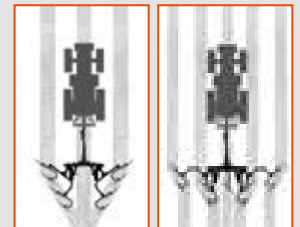

"V" rakes can be used for raking, turning and spreading



Two hydraulic cylinders with ball valves



Narrow 8" transport width



Springs adjust the pressure of the wheels to the ground

HRC-08V	HRC-10V	HRC-12V
30-80	30-80	30-80
8	10	12
56"	56"	56"
40	40	40
3/32"	3/32"	3/32"
21'4"	23'4"	25'7"
8'	8'	8'
8'10"	10'	12'1"
14	14	14
1,290	1,457	1,623
\$ 5,910	\$ 6,569	\$ 7,275

- Working speed of up to 14 mph, low costs of maintenance, and ease of use make these units indispensable for raking hay.
- Floating rake wheels with spring steel tines follow ground contour evenly.
- Multiple adjustment capabilities allow operator to adjust raking width, windrow width and raking angle.
- Pull type 8, 10 and 12 wheel rakes with double action hydraulic cylinders for easy transportation and storage.
- Hydraulic ball valves allow for single side operation and lock rakes during transport and storage.
- Narrow 8' transport width allows rakes to be easily transported to different work locations.
- 8 and 12 wheel rakes may be adjusted to spread or turn crop.
- Optional center kicker wheel with additional hydraulic cylinder.

Before Price List - 8-1-2020

TEDDERS

20-60 HP (15-45 KW)
 540 rpm



- Heavy frame construction.
- High strength steel tine arms.
- Large diameter 15" x 6" pneumatic tires.
- Easy pull type hook up.
- Heavy duty shielded PTO shaft with ratchet torque limiter.
- Spring steel double hay tines.
- Sturdy guard rail for added safety.

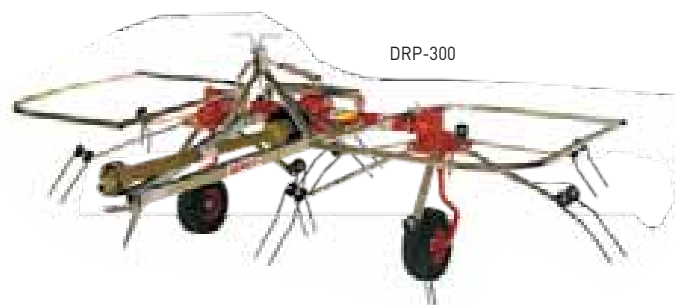

MODEL	DRP-300	DRP-480
HP	20-50	30-60
ft	10'	16'
lbs	408	738
N°	2	4
N°	6	6
1 3/8"	ASAE cat. 2 ratchet torque limiter	ASAE cat. 4 ratchet torque limiter
\$	\$ 3,570	\$ 7,116

All DRP-300 are crated 2 each. Add \$50 net for single order units.

STANDARD

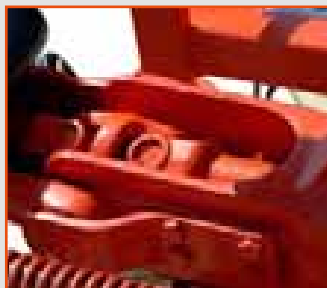

DRP-480 double yoke joint transmission



DRP-480 in transport position

Bid Term - 2/22/19 - 2/21/21; Extended to 2/21/22

OPTIONALS PAG. 75



WINDROWER RAKES

20-50 HP (15-37 KW)
 540 rpm - cat. 1 & 2









STANDARD



Heavy duty gearbox with raking depth adjustment handle

- Heavy frame construction.
- Heavy duty shielded PTO shaft (1 3/8" ASAE cat. 1) with ratchet torque limiter.
- Tubular steel tine arms.
- Large diameter pneumatic tires.
- Spring steel double hay tines.
- Easy tine arm removal system.
- Sturdy guard rail for added safety.
- Angled tines for high clearance.
- 3 point linkage, cat. 1 & 2.







MODEL	DR0-308	
	HP	20-50
	ft	10'
	lbs	650
	N°	8
	N°	3
	1 3/8"	ASAE cat. 1 ratchet torque limiter
		\$ 5,291

Bid Term - 2/22/19 - 2/21/21; Extended to 2/21/22

QUICK HITCH



- ASABE cat. 1 Quick Hitch.
- Works with all BEFCO cat. 1 Quick Hitch compatible implements.
- Look for the  symbol throughout the catalog for compatible implements.
- Optional floating Quick Hitch Adapter for C30, C50 & C70 grooming mowers. Adapter allows mowers to maintain its full float capability while using Quick Hitch.
- Optional Quick Hitch adapter available for Hop 203 fertilizer spreader.

MODEL	QH1-100	
		Cat. 1
	in	30 1/2"
	in	22"
	in	8"
	lbs	57
		\$ 504

OPTIONALS



OPTIONALS

CYCLONE C30-CE5

005-600 • Mulching kit **\$ 382**

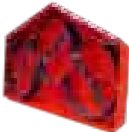

001-600 • Front antiscalping roller **\$ 127**



OPTIONALS

CYCLONE C30

• Mulching kit

004-600	C30-RD4	\$ 329
005-600	C30-RD5	\$ 382
006-600	C30-RD6	\$ 409



001-600 • Front antiscalping roller **\$ 127**



001-700 • Quick hitch adapter **\$ 452**

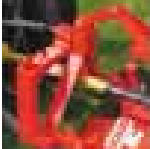

OPTIONALS

CYCLONE C50

• Mulching kit

005-700	C50-RD5	\$ 394
006-700	C50-RD6	\$ 449
007-700	C50-RD7	\$ 525



009-9915 • Front antiscalping roller (standard on C50-RD7 model) **\$ 144**



• Rear roller kit

009-9941	C50-RD5	\$ 813
009-9942	C50-RD6	\$ 840
009-9943	C50-RD7	\$ 864



002-800 • Quick hitch adapter **\$ 423**



OPTIONALS

CYCLONE C70

002-800

• Quick hitch adapter

\$ 423



OPTIONALS

CYCLONE FLEX

009-9817

• Hydraulic unlocking system

\$ 606



• Mulching kit

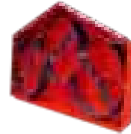

009-9556

312-FLX **\$ 1,130**

009-9557

315-FLX **\$ 1,237**

009-9558

317-FLX **\$ 1,347**

009-9597

• Floating hitch, additional

\$ 279



009-9599

• Roadway kit

\$ 492



• Rear roller kit

009-9945 312-FLX **\$ 2,387**

009-9946 315-FLX **\$ 2,466**

009-9947 317-FLX **\$ 2,520**



OPTIONALS

CYCLONE SUPER FLEX

009-9817

• Hydraulic unlocking system

\$ 606



• Mulching kit

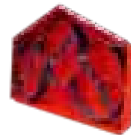

009-9556

412-SFL **\$ 1,130**

009-9557

415-SFL **\$ 1,237**

009-9558

417-SFL **\$ 1,347**

009-9559

420-SFL **\$ 1,575**

009-9597

• Front floating hitch, additional

\$ 279



009-9599

• Roadway kit

\$ 492

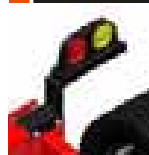



009-9950	412-SFL	\$ 2,449
009-9951	415-SFL	\$ 2,526
009-9952	417-SFL	\$ 2,577
009-9953	420-SFL	\$ 2,655

OPTIONALS HURRICANE H40

009-9507

• Side skirts

\$ 118



009-9560

• Overrunning clutch for driveline

\$ 153



• Rotor with dethatching blades (factory installed)

DBD48H40 H40-048 net \$ 326

DBD60H40 H40-060 net \$ 366

DBD72H40 H40-072 net \$ 395



• Rotor with reverse "Y" blades (factory installed)

YBD48H40 H40-048 net \$ 205

YBD60H40 H40-060 net \$ 205

YBD72H40 H40-072 net \$ 205



• Rotor with triangular paddle blades (factory installed)

TBD48H40 H40-048 net \$ 205

TBD60H40 H40-060 net \$ 205

TBD72H40 H40-072 net \$ 205



• Rotor with hammers (factory installed)

HBD48H40 H40-048 net \$ 332

HBD60H40 H40-060 net \$ 423

HBD72H40 H40-072 net \$ 496

OPTIONALS HURRICANE H40-S

009-9206

• Side skirts

\$ 138



009-9560

• Overrunning clutch for driveline

\$ 153



• Rotor with dethatching blades (factory installed)

DBD48H40 H40-S48 net \$ 326

DBD60H40 H40-S60 net \$ 366

DBD72H40 H40-S72 net \$ 395

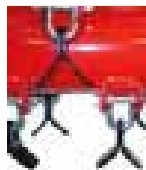

• Rotor with reverse "Y" blades (factory installed)

YBD48H40 H40-S48 net \$ 205

YBD60H40 H40-S60 net \$ 205

YBD72H40 H40-S72 net \$ 205

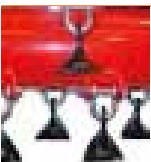

• Rotor with triangular paddle blades (factory installed)

TBD48H40 H40-S48 net \$ 205

TBD60H40 H40-S60 net \$ 205

TBD72H40 H40-S72 net \$ 205



• Rotor with hammers (factory installed)

HBD48H40 H40-S48 net \$ 332

HBD60H40 H40-S60 net \$ 423

HBD72H40 H40-S72 net \$ 496

009-9207

Hydraulic cylinder for side shift

NJ State Approved Cop #65447

65447 ESCOPS Grounds Equipment - Bid #

009-9208

H40-S48

\$ 169



009-9209

H40-S60

\$ 203

009-9210

H40-S72

\$ 245

RVRXXH40

• Reverse rotation (factory installed)

net \$ 307



OPTIONALS HURRICANE H70

009-9691

• Gauge wheels with laminated tires H70

\$ 1,060



009-9701

• Gauge wheels with laminated tires H80

\$ 1,257



• Rotor with dethatching blades (factory installed)

DBD60H70 H70-060 net \$ 366

DBD72H70 H70-072 net \$ 406

DBD88H70 H70-088 net \$ 446



• Rotor with reverse "Y" blades (factory installed)

YBD60H70 H70-060 net \$ 205

YBD72H70 H70-072 net \$ 205

YBD88H70 H70-088 net \$ 205



• Rotor with triangular paddle blades (factory installed)

TBD60H70 H70-060 net \$ 205

TBD72H70 H70-072 net \$ 205

TBD88H70 H70-088 net \$ 205



• Rotor with hammers (factory installed)

HBD60H70 H70-060 net \$ 423

HBD72H70 H70-072 net \$ 510

HBD88H70 H70-088 net \$ 598

RVRXXH70

• Reverse rotation (factory installed)

net \$ 307



OPTIONALS DESTROYER D90

GDTXXD90

• Gearbox with dual PTO (factory installed)

net \$ 275



009-9969

• Side skirts

\$ 246



OPTIONALS

BM6-2HR

BM6-000

• 15" blower pipe extension

\$ 164



OPTIONALS

TORNADO BRC

009-9986

• Side skids

\$ 44



OPTIONALS

TILL-RITE T30

RVRXXT30

• Reverse rotation (factory installed)

net \$ 307



OPTIONALS

TILL-RITE T40

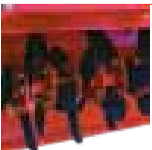

• Aerator rotor

009-9852 T40-150, T40-250 **\$ 1,104**

009-9853 T40-158, T40-258 **\$ 1,293**

009-9854 T40-166, T40-266 **\$ 1,502**

RVRXXT40

• Reverse rotation

net \$ 307



OPTIONALS

TILL-RITE T50

RVRXT50

• Reverse rotation (factory installed)

net \$ 307



OPTIONALS

TILL-RITE T60

RVRXT60

• Reverse rotation (factory installed)

net \$ 307



OPTIONALS

TILL-RITE T70

RVRXT70

• Reverse rotation (factory installed)

net \$ 307



OPTIONALS

GREEN-RITE GRT

009-9875

• Gauge wheels for all models

\$ 427



• Front roller

009-9648

GRT-250

\$ 677



009-9516

GRT-258

\$ 715

009-9563

GRT-266

\$ 774

009-9566

GRT-282

\$ 835

Note: units may utilize gauge wheels or front roller for depth control, but not both

• Tiller rotor

009-9649

GRT-250

\$ 669

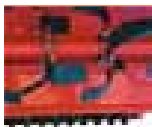

009-9517

GRT-258

\$ 756

009-9564

GRT-266

\$ 840

009-9567

GRT-282

\$ 1,563

• Rear roller scraper

009-9189

GRT-250

\$ 234

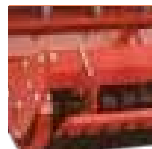

009-9539

GRT-258

\$ 268

009-9565

GRT-266

\$ 373

009-9568

GRT-282

\$ 425

Berco Price List 8-1-2020
Cast Iron Roller Rings
(factory installed)

CSR50GRT	GRT-250	net \$ 487
CSR58GRT	GRT-258	net \$ 540
CSR66GRT	GRT-266	net \$ 593
CSR82GRT	GRT-282	net \$ 719



009-9139	GRT-250	\$ 98
009-9140	GRT-258	\$ 115
009-9141	GRT-266	\$ 129
009-9142	GRT-282	\$ 161



OPTIONALS SEED-RITE SRT

CSR74SRT

• Cast iron roller rings (factory installed)

net \$ 1,485



009-9985

• Seed rate speed reduction kit

\$ 85



009-9138

• Seed conveyor kit

\$ 145



009-9930

• Rear expanded roller frame for seed covering/
dethatching with adjustable tickler tines

\$ 612



OPTIONALS MOLE 200 / 300

009-9851

• Hook-up stand all models

\$ 450



009-9154

• Hydraulic down force kit 200-512

\$ 677



009-9155

• Hydraulic down force kit 300-512 & 400-512 model

\$ 694

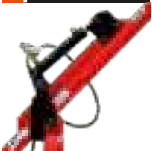

PHD-003

• Auger positioning handle all models

\$ 165

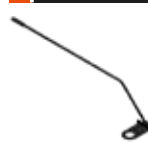

OPTIONALS BABY-HOP POLY BABY-HOP

AA1-120

• Deflector shield

\$ 104



009-9856

• Remote gate control

\$ 367





009-9720	for all 103 models	\$ 224
009-9721	for all 106 models	\$ 233

OPTIONALS HOP POLY-HOP

009-9979 • Tumbling style agitator for all 203 models \$ 87



009-9978 • Tumbling style agitator for all 206, 209 & 212 models \$ 87



009-9458 • Side row discharge for all 209 & 212 models \$ 438



009-9524 • Deflector shield for all 203 & 206 models \$ 104



009-9638 • Deflector shield for all 209 & 212 models \$ 199



009-9856 • Remote gate control for all 203 models \$ 367



009-9850 • Remote gate control for all 206, 209 & 212 models \$ 367



009-9913 • Filter grate for all 209 & 212 models \$ 500



• Hopper cover **009-9720** for all 203 models \$ 224



009-9721 for all 206 models \$ 233

009-9722 for all 209 models \$ 250

009-9723 for all 212 models \$ 258

009-9239 • Quick hitch adapter for all 203 models \$ 46



OPTIONALS TURBO-HOP 301

009-9452 • Short spout for sand and salt \$ 336



009-9451 • Rubber insert for damp material \$ 121



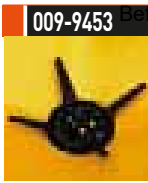

009-9453

Agitator extension

\$ 200



009-5370

Left only & right only directional attachment

\$ 82



001-4984

Locking nut for spout

\$ 52

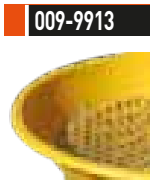

009-9913

Filter grate

\$ 500

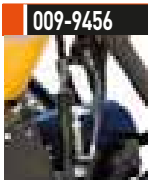

009-9456

Hydraulic control

\$ 729



Hopper cover

009-9722 301-300

\$ 250

009-9723 301-400

\$ 258

OPTIONALS TURBO-HOP 303

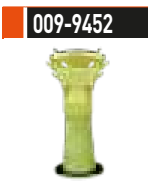

009-9452

Short spout for sand and salt

\$ 336



009-9451

Rubber insert for damp material

\$ 121

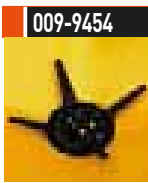

009-9454

Agitator extension

\$ 200



009-5370

Left only & right only directional attachment

\$ 82



001-4984

Locking nut for spout

\$ 52

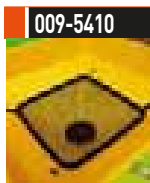

009-5410

Filter grate

\$ 475

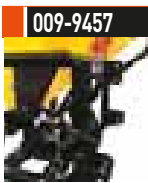

009-9457

Hydraulic control

\$ 729



Hopper cover

009-9725 303-600

\$ 284

009-9726 303-800

\$ 291

009-9727 303-999

\$ 305

OPTIONALS

CORE AERATOR SD



- Steel weight sand tank, price per unit

009-9731	BCA-048	\$ 305
009-9732	BCA-060	\$ 318
009-9733	BCA-072	\$ 332



- Unit with spikes instead of spoons (factory installed)

SP048BCA	BCA-048	net \$ 332
SP060BCA	BCA-060	net \$ 414
SP072BCA	BCA-072	net \$ 492

FRTSDBC

- Front mounted (factory installed)

net \$ 205



OPTIONALS

CORE AERATOR HD



- Steel weight sand tank, price per unit

009-9734	BCA-260	\$ 358
009-9735	BCA-272	\$ 385



- Unit with spikes instead of spoons, (factory installed)

SP260BCA	BCA-260	net \$ 568
SP272BCA	BCA-272	net \$ 723

FRTHDBC

- Front mounted (factory installed)

net \$ 205



OPTIONALS

SOIL PULVERIZERS SD

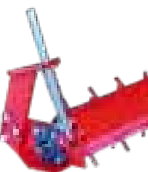

- 2nd rear roller assembly Ø 5"

009-9887	BPL-048	\$ 546
009-9636	BPL-060	\$ 635
009-9637	BPL-072	\$ 774

OPTIONALS

SOIL PULVERIZERS HD

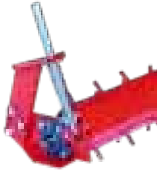

• 2nd rear roller assembly Ø 5 7/16"

009-9646 BPL-272 \$ 904

009-9647 BPL-284 \$ 973

OPTIONALS

REAR BLADE SD

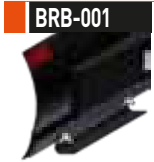

BRB-001

• Skid shoes

\$ 85

OPTIONALS

REAR BLADE HD



BRB-001

• Skid shoes

\$ 85



BRB-002

• Hydraulic offset control

\$ 342

OPTIONALS

LANDSCAPE RAKE BLR



009-9159

• Gauge wheels (standard duty series)

\$ 582

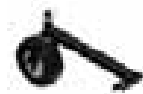

BLR-002

• Gauge wheels (subcompact series)

\$ 436

OPTIONALS

FINGER WHEEL "V" RAKES

009-9982

• Kicker wheel for HRC models
(includes hydraulic cylinder)

\$ 631



OPTIONALS

TEDDERS

009-9966

• Hydraulic lift kit for model DRP-480

\$ 1,157



**USE ONLY
BEFCO ORIGINAL SPARE PARTS**

FOR YOUR REFERENCE:

Dealer Account number

Rep name

Rep telephone

Sales telephone

(800) 334-6617

Sales fax

(252) 977-9718

Sales e-mail

sales@befco.com

Parts telephone

(877) 663-3458

Parts fax

(800) 265-6962

Parts e-mail

parts@befco.com

LIMITED WARRANTY

BEFCO's responsibility will be limited to the substitution of the acknowledged defective merchandise to the same place of delivery as the previous one was supplied.

1. LIMITED WARRANTY

BEFCO, Inc. herein referred to as the Company, warrants its machines and related accessories, hereafter referred to as the Machine, to be free from defects in material and workmanship, for a period of twelve (12) months from the date of invoice to the first registered owner; **this limited warranty does not apply to and excludes shear bolt and/or slip clutch, oil, grease, tires, tubes, hydraulic hoses, knives, blades, augers, and PTO shafts.** Labor will be reimbursed at \$40.00 per hour based on BEFCO's time schedule.

Cost of transport to the servicing dealer is the responsibility of the customer.

Warranty coverage shall not be transferable from the first owner to any subsequent owner.

2. DISCLAIMER OF ALL OTHER WARRANTIES AND REMEDIES

Neither the Company nor any company affiliated with the Company makes any warranties, expressed or implied, as to the quality, performance or application of its products other than those set forth herein and does not make any implied warranty of merchantability or fitness. The only remedies the purchaser has in connection with the breach, or performance of any warranty on the Company's Machine are those set forth herein. In no event will the dealer, the Company, or any company affiliated with the Company be liable for:

- (a) Injuries or damages of any kind of nature, direct, consequential or contingent to person or property.
- (b) Any expenses incurred by the owner to repair, replace or rework any allegedly defective item.
- (c) Any loss, cost, forfeiture or damages (including loss of profits; loss of crops; loss because of delay in field operations; any expense or loss incurred for labor, supplies, substitute machine rental; liabilities of the owner to its customers or third persons; and all other consequential damages, losses, liabilities or damages for any other reasons; whether direct or indirect, and whether or not resulting from or contributed to by the default or negligence of the Company, its agents, employees and subcontractors which might be claimed as a result of the use or failure of the equipment delivered.

The Company's liability based on this limited warranty or any other applicable laws shall be limited to replacement or refund of the purchase price of the product.

The limited warranty extended herein gives you specific rights and you may also have other rights which vary from state to state. Neither the dealer nor the Company personnel has the authority to make any representation or to modify the terms and limitations of this warranty in any way. Other than the limited warranty extended hereby, there is no other expressed warranty in connection with the design, safety or use of any of the Company's products except as to title. All implied warranties are expressly disclaimed pursuant to the terms of this warranty.

3. CUSTOM WORK

If the Machine is used for commercial purposes, such as custom work, the period warranted for the Machine is limited to 180 days from the date of delivery to the first registered owner and does not cover any labor charges incurred.

4. RENTAL

If the Machine is used for rental purposes the period warranted for the Machine is limited to thirty (30) days from the date of delivery to the first registered owner and does not cover any labor charges incurred.

5. REGISTRATION

In order to qualify for coverage on this limited warranty, the product and name of the original purchaser must be registered with the Company by mailing a completed Machine Pre-Delivery Checklist and Warranty Registration along with a copy of the dealer's invoice to the first registered owner to the Company within fourteen (14) days after the date of delivery to the original purchaser.

6. WARRANTY SERVICE

Warranty Service must be performed by a dealer authorized by BEFCO. If the warranty service requested is approved, the owner shall pay only for labor beyond the rate allowed, for overtime labor, and for any mileage charge for transporting the equipment to and from the dealer's shop. It is assumed that the dealer has the appropriate general and special tools to service the Machine. Time required for replacement of knives, oil, grease and to remove excessive dirt from the Machine is not subject to reimbursement by the Company. The owner is required to clean the Machine before presenting it to the dealer for service work. The Machine must be delivered within thirty (30) days after failure date by the owner to the dealer to be eligible for warranty consideration.

7. UNAPPROVED SERVICE OR MODIFICATION

All obligations of the Company under this limited warranty shall be terminated if:

- (a) Proper service and operation Instructions, as outlined in the Operator's Manual and on the instruction sticker on the Machine, are not followed.
- (b) The Machine is modified or altered in any way not approved by the Company.
- (c) The Company does not receive a copy of the dealer's invoice to the first registered owner within fourteen (14) days from the date of delivery.
- (d) The Company has not been paid in full, by the dealer, for the Machine.

8. ACCIDENTS AND NORMAL MAINTENANCE

This limited warranty covers defective material and workmanship. It does not cover depreciation or damage caused by normal wear, accidents, improper maintenance, or improper use. The costs of normal maintenance or repairs for accidents or improper use, and related labor, will be borne by the owner.

GENERAL SELLING CONDITIONS

The purpose of the **Befco**® Sales Program is two-fold. First, the program is designed to offer **Befco** dealers, distributors and retailers purchasing directly from **Befco** (each direct purchaser, referred to as "Buyer") an incentive for early booking of orders and to provide financing for Buyers to maintain an adequate inventory of **Befco** brand wholegoods (the "Equipment") prior to and during the selling season. Second, the program enables **Befco** to plan production requirements more accurately in order to make Equipment available on a timely basis. This combination of incentives and financing places **Befco** and its Buyers in a position to achieve a greater market share within a competitive environment. Although **Befco** offers quantity discounts, **Befco** does not require any **Befco** Buyer to purchase or maintain any minimum quantity of Equipment. The **Befco** Buyer may elect at its sole discretion to purchase a sufficient quantity of Equipment to maintain a regular inventory, or may elect to order Equipment only as desired or needed to meet custom requests. The inventory program and level of inventory shall be in the Buyer's discretion. All such orders will be processed in accordance with the Sales Program and these General Selling Conditions in effect. The following information provides details of the **Befco** Sales Program Terms and Conditions.

1. Requirements to Qualify: The terms of sale to Buyers are applicable only to Equipment purchased directly from **Befco**. **Products covered by any order accepted by Befco will be shipped at prices, terms and discounts in effect at time of order unless otherwise specified. The terms and conditions contained herein are subject to change without notice.**

2. Credit Approval: All orders or shipping instructions will be subject to approval by **Befco** prior to shipment. Copies of current Buyer's financial statements are required annually, and signed Security Agreements must be on file where applicable.

3. Trade Discounts: A trade discount may be allowable pursuant to **Befco's** current suggested list price on Equipment.

4. Qualifying and Non-Qualifying Buyers: **Befco** has the right to classify Buyers as either qualifying or non-qualifying; thereby changing the trade discount as indicated in the schedule of Terms and Discounts.

5. Accumulative Quantity Discounts: Accumulative Quantity Discounts are allowed on all **Befco** Equipment and accessories to **Befco Buyers** and are subject to the following conditions:

- Accumulative Quantity Discounts accumulate with each new order, but are not retroactive and will apply only during periods as defined in the current suggested retail price listing or schedule of Terms and Discounts.
- Shipments of Pre-Season Orders will be made at the Company's convenience.
- The Accumulative Quantity Discount is calculated after deducting the Trade Discount.
- Units not paid by the due date will be subject to loss of the Accumulative Quantity Discount plus 1% monthly service charge until paid in full.

6. Cash Discount: Cash discounts are determined by the date of invoice to the Buyer and are calculated on the net balance after all applicable discounts. See specific programs for schedule of cash discounts.

7. Settlement: Payment for Equipment is due immediately following delivery to Buyer's customer, or as specified by invoice due date whichever is earlier. **Any equipment not paid for immediately after delivery to Buyer's customer is considered "out-of-trust" and all discounts are voided and full list price shall be immediately due and payable.**

8. Past Dues & Legal: Past due accounts will have a service charge of 1% per month. Cost of attorney fees for collections of past due accounts will be borne by the Buyer.

9. Requested Shipping Dates & Discounts: Pre-Season Orders will be shipped at **Befco's** convenience. Refusal by the Buyer to accept shipment will disqualify the order. It is the intent of **Befco** to keep freight costs to a minimum, therefore requesting specific shipping dates is not acceptable.

10. Freight Policy:

- All prices are F.O.B. Rocky Mount, North Carolina.
- Pre-Season at **Befco's** convenience. The rate is published each year in the **Befco Terms and Discounts** freight rate section.
- No freight will be charged if the Buyer picks up the Equipment at the Rocky Mount factory.
- Emergency and urgent In-Season shipments will be shipped LTL freight collect.**
- Units from depot outside Rocky Mount, North Carolina, will be shipped LTL Freight Collect. This is in addition to a back freight charge.
- All freight invoices are due Net 30 Days. Past due freight invoices will be charged the standard 1% per month service charge.
- Befco** is not responsible for Equipment or parts damaged or lost in transit.
- The Buyer is responsible for filing a freight claim with the trucking company for lost or damaged Equipment.
- Any applicable duties or tariffs will be the responsibility of and must be paid by the Buyer or other party receiving the order.
- All parts orders are shipped F.O.B. Rocky Mount, N.C.

11. Buyer Inspection/Acceptance; Returns: Buyer shall inspect all Equipment within ten (10) days following delivery (the "Inspection Period") and shall notify the freight forwarder and **Befco** of any claim for damages or shortages. To reject a unit of Equipment for nonconformity with the specifications set forth in **Befco's** documentation for that unit in effect at the time of Buyer's purchase order for such unit, Buyer shall notify **Befco**, within the Inspection Period, in writing of its rejection and shall promptly return the rejected unit in original condition to **Befco**, with insurance and freight prepaid. After receipt of the properly rejected unit, **Befco** at its option shall either repair or replace such properly rejected unit or refund any purchase price paid by Buyer, along with Buyer's return cost of transportation. **Befco** will prepay transportation charges for repaired/replacement units back to Buyer and will reimburse Buyer for the cost of transportation incurred by Buyer in connection with the return of properly rejected units. Any unit not properly rejected within the Inspection Period shall be deemed accepted.

12. Standard Limited Warranty: Buyer shall pass on to his customers **Befco's** standard limited warranty or warranties for the **Befco** Equipment, as such warranty or warranties may be amended from time to time by **Befco**. **Befco** shall not be liable for any other warranties or similar obligation made or given by Buyer.

Except for the standard limited warranty to end user customers of Befco Equipment; Befco grants no other warranties, express or implied, by statute or otherwise, regarding the equipment, their fitness for any purpose, their quality, their merchantability or otherwise. In no event shall Befco be liable for any special, consequential or incidental damages for breach of warranty or any special, consequential or incidental damages, including injury or damage to business, earnings, profits or goodwill suffered by Buyer or any other person and caused directly or indirectly by the equipment sold.

13. Technical and Price Information: Technical information provided in the catalog is approximate. **Befco** reserves the right to modify or improve the models listed for technical or commercial purposes and all prices are subject to change without notice.

BEFCO



BEFCO, Inc.
1781 South Wesleyan Blvd.
P.O. Box 6036
Rocky Mount, NC 27802-6036
Tel: 252.977.9920 - Fax: 252.977.9718
www.befco.com



08/2020 - 1500

All rights reserved. It is unlawful to copy, reprint or use any of the information or details indicated in this document without the expressed permission of BEFCO, Inc. Rocky Mount, NC. Technical information provided in this document is approximate, the Company reserves the right to modify or improve the models shown for technical or commercial purposes. Pictures in this manual do not necessarily show the machine as delivered.